

10" 15 AMP COMPOUND MITER SAW Operator's Manual

Save This Manual

You will need this manual for safety instructions, operating procedures and warranty.

Place it and the original sales receipt in a safe, dry location for future reference

Toll Free Customer Service

For questions / comments, technical assistance or repair parts:

Please call toll free at
1-877-886-6822
(Mon - Fri 8am - 5pm CST)



Table of Contents

Safety instructions	2-4
Specifications	5
Features	6
Assembly Adjustments	7
Saw Operations	8
Maintenance	9
Warranty	10

Safety Instructions

WARNING: *When using electric tools, machines or equipment, basic safety precautions should always be followed to reduce the risk of fire, electric shock, and personal injury*

General Safety Rules For Electrical Power Tools

Work Area

- **Keep work area clean and well lit.** Cluttered and dark areas can cause injuries.
- **Do not operate power tools near flammable liquids, gases or dust.** Power tools create sparks which may ignite the dust or fumes.
- **Operation of this saw requires the full attention of the operator.** Distractions can cause accidents.
- **Store idle tools out of reach of children and other untrained persons.** Give these safety regulations to all persons who work on the machine.
- **Do not leave tool running unattended, turn power off.** Do not leave tool until it comes to a complete stop.
- **MAKE WORKSHOP CHILDPROOF.** Padlock, master switches, and remove power cord from outlet.

Electrical Safety

- **Before plugging in the tool, be certain the outlet voltage supplied is compatible with the voltage marked on the nameplate.** An outlet voltage incompatible with that specified on the nameplate can result in serious hazards and damage to the tool.
- **Double insulated tools are equipped with a polarized plug (one blade is wider than the other). This plug will fit in a polarized outlet only one way. If the plug does not fit fully in the outlet, reverse the plug. If it still does not fit, contact a qualified electrician to install a polarized outlet. Do not change the plug in any way.** Double insulation eliminates the need for the three wire grounded power cord and grounded power supply.
- **Avoid body contact with grounded surfaces such as pipes, radiators, ranges and refrigerators. There is an increased risk of electric shock if your body is grounded.**
- **Do not expose power tools to rain or wet conditions.** Water entering a power tool will increase the risk of electric shock.
- **Do not abuse the cord. Never use the cord to carry the tools or pull the plug from an outlet. Keep cord away from heat, oil, sharp edges or moving parts. Replace damaged cords immediately.** Damaged cords increase the risk of electric shock.
- **When operating a power tool outside, use an outdoor extension cord marked “w-A” or “w”.** These cords are rated for outdoor use and reduce the risk of electric shock.

Personal Safety

- **Stay alert, watch what you are doing and use common sense when operating a power tool.** A moment of inattention or use of drugs, alcohol or medication while operating power tools can be dangerous.
- **Dress properly. Do not wear loose clothing or jewelry. Contain long hair. Keep your hair, clothing and gloves away from moving parts. Loose clothes, jewelry or long hair can be caught in moving parts.** Roll long sleeves above elbows. Rubber gloves and nonskid footwear are recommended when working outdoors.
- **Avoid accidental starting. Be sure switch is “OFF” before plugging in.** Carrying tools with your finger on the switch or plugging in tools that have the switch “ON” invites accidents.
- **Remove adjusting keys or wrenches before turning the tool “ON”.** A wrench or a key that is left attached to a rotating part of the tool will be thrown.
- **Do not overreach, keep proper footing and balance at all times.** Proper footing and balance enables better control of the tool in unexpected situations.
- **Do not stand on tool or its stand.** Serious injury may occur if the tool is tipped or if the cutting tool accidentally contacted. Do not store materials on or near the tool such that it is necessary to stand on the tool or its stand to reach them.
- **Use safety equipment. Always wear safety goggles.** Dust mask, safety shoes, hard hat or hearing protection must be used for appropriate conditions. Everyday eyeglasses only have impact resistant lenses. They are **NOT** safety glasses

Tool Use and Care

- **Use clamps or other practical way to secure and support the workpiece to a stable platform.** Holding the work by hand or against your body is unstable. It allows for work to shift, causes binding of the tool and loss of control.
- **Do not force tool. Use the correct tool for your application.** The correct tool will do the job better and safer at the rate for which it is designed. Do not use the tool for purpose not intended - for example; do not use the miter saw for slicing meats.
- **Do not use tool if switch does not turn it “ON” or “OFF”.** Any tool that cannot be controlled with the switch is dangerous.
- **Disconnect the plug from the power source before making any adjustments or changing accessories.** Such preventive safety measures reduce the risk of starting the tool accidentally.
- **Keep cutting tools sharp and clean. Properly maintained tools, with sharp cutting edges, are less likely to bind and easier to control.** When mounting saw blades be certain that the arrow on the blade matches the direction of the arrow marked on the tool and that the teeth are also pointing in the same direction.
- **Inspect guards before using a tool. Keep guards in place.** Check moving parts for binding or any other condition that may affect the normal operation or safety features of the tool. If damaged, have tool serviced before using the tool. Many accidents are caused by poorly maintained tools.
- **Do not alter or misuse tool.** Any alteration or modification is a misuse and may result in serious personal injury.
- **The use of any other accessories not specified in this manual may create a hazard.** Accessories that may be suitable for one type of tool, may become hazardous when used on an inappropriate tool.

Service

- **Tool service must be performed only by qualified repair personnel.** Service or maintenance performed by unqualified personnel may result in misplacing internal wires and components which could cause serious hazard.
- **When servicing a tool, use only identical replacement parts.** Follow instructions in the maintenance section of this manual. Use of unauthorized parts or failure to follow Maintenance Instructions may create a hazard.

**For questions / comments, technical assistance or repair parts:
Please call toll free at 1-877-886-6822 (Mon – Fri 8am – 5pm CST)**

Special Safety Rules For Compound Miter Saws

- 1. WOOD ONLY.** The saw is designed for woodcutting only.
- 2. DAMAGED OR WARPED SAW BLADES** should not be used. They are out of balance and could cause further damage to the saw and possible personal injury.
- 3. USE ONLY WITH GUARD IN PLACE.** The guard protects the operator from cutting debris as well as from broken pieces of the blade, should it break in use.
- 4. REPLACE THE TABLE INSERT WHEN WORN.** Excessive tear-out increases the likelihood of injury from flying debris. When setting the saw at a new angle, check that the blade does not cut into the table insert, rear fence, or another part of your saw.
- 5. ALWAYS USE THE BLADE WRENCH** to tighten the saw blade onto the arbor.
- 6. CONNECT YOUR MITER SAW TO A DUST COLLECTING DEVICE** if possible. If not, use the dust bag that comes with the tool and empty it regularly.
- 7. USE A SAWBLADE SUITED TO THE CUTTING JOB AND MATERIAL TO BE CUT.**
- 8. ALWAYS USE TABLE EXTENSIONS AND CLAMPS** to support the material when sawing long work pieces.
- 9. THE MATERIAL SHOULD BE PLACED FIRMLY AGAINST THE FENCE AND TABLE.** The turning of the saw blade should force it down against the table and rearward against the fence during the cut. Movement of the workpiece during the cut may cause the blade to jam and create a kickback. When this happens, the cutting head may jump out of your hand or the workpiece may fly loose and cause serious injury.

Tool Shop Miter Saw #240-2099 Specifications

Rated Voltage	15 Amp 120V – 60Hz
Blade Speed	4,800 rpm (No-Load Speed)
Blade Diameter	10" (40T Carbide Tip)
Positive Miter Stops	0°, 15°, 22.5°, 30°, & 45°
Miter Angle	45° Left / 45° Right
Bevel Angle	45° Left
Arbor Size	5/8"
Power Cord	6-1/2 ft.
Weight	28.6 lbs.
Cutting Capacity	
90° Cross Cut	max. 2-3/4" x 5"
45° Miter Cut	max. 2-3/4" X 3-1/2"
45° Bevel Cut	max. 1-1/2" X 5"
45° Miter / 45° Bevel Cut	max. 1-1/2" X 3-1/2"

Features

- 1) Blade Lock
- 2) Handle
- 3) On/Off Switch
- 4) Machine Head
- 5) Saw Blade
- 6) Saw Blade Guard, Hinged
- 7) Fence
- 8) Table
- 9) Base Plate, Fixed
- 10) Miter Table Knob
- 11) Bevel Lock Lever
- 12) Table Extensions
- 13) Sawdust Bag
- 14) Bevel Scale
- 15) Retaining Pin
- 16) Miter Scale
- 17) Miter Lock Knob
- 18) Material Hold Down Clamp
- 19) Material Hold Down Clamp Receptacle
- 20) Miter Degree Angle Indicator
- 21) Plastic Kerf Plate Table Insert
- 22) Bevel Degree Angle Indicator
- 23) Rear Stability Bar
- 24) Brush Cover Plate
- 25) Phillips Headed Hex Wrench
- 26) Table Extension Mounts
- 27) Table Extension Fasteners
- 28) Material Hold Down Clamp Thumb Screw
- 29) 90° Bevel Nut
- 30) 90° Bevel Screw
- 31) 45° Bevel Nut
- 32) 45° Bevel Screw
- 33) Sawdust Exhaust Port
- 34) Blade Cover Plate Screws
- 35) Cooling Vents

Figure 1

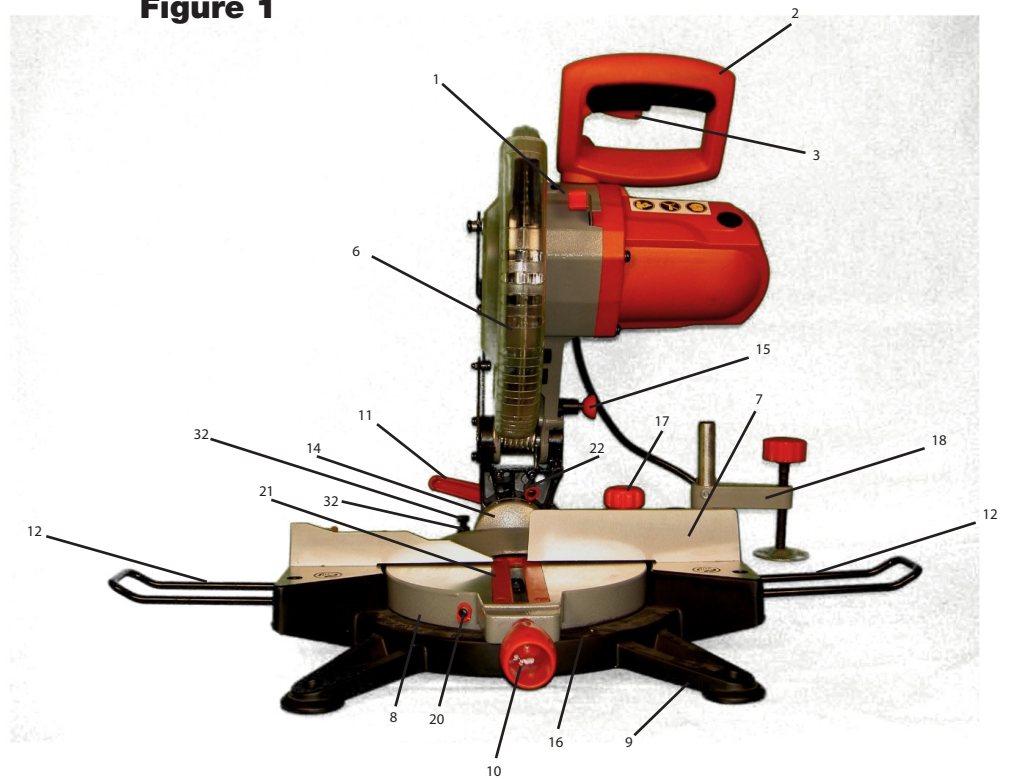
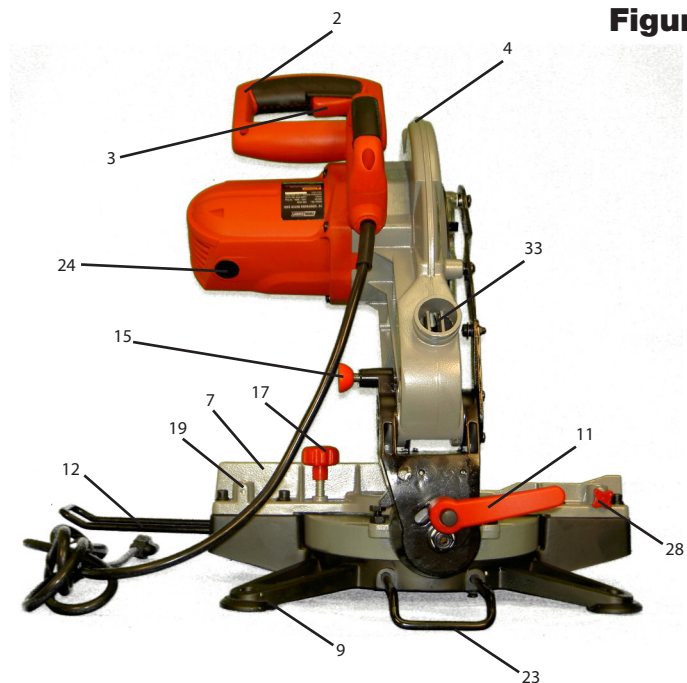

Figure 2



Assembly and Adjustments

ITEMS INCLUDED

- Miter Saw
- Hex Wrench
- Material Clamp
- Dust Bag
- Dual Material Extensions
- Stability Bar

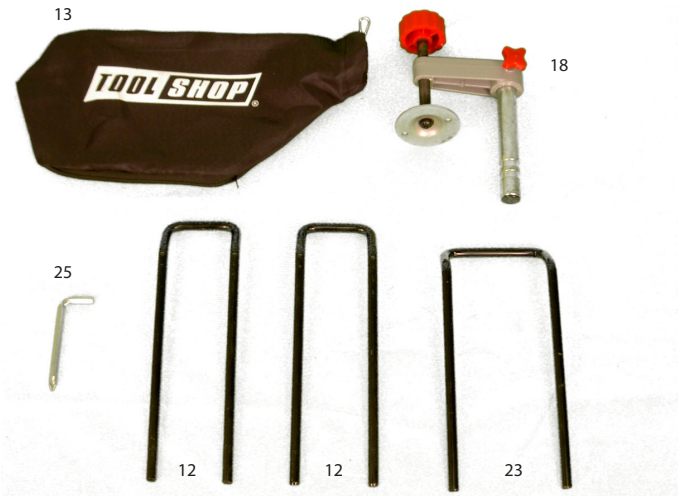

Figure 9

Assembly

A. Setting up the saw (Fig. 1 & 2)

- Insert the two table extensions (12) into the mounts (26) provided on the side and fasten them in place with fasteners (27).
- Insert the clamping device (18) into one of the two receptacles (19) provided on top of stop rail and fasten in place with the thumb screw (28).
- Attach the rear stability bar (23) to the back of the machine.

B. Adjusting the saw (Fig. # 1 & 3)

- To adjust the miter table (8), grab hold of miter table knob (10) and move to desired degree on miter scale (16).
- The miter scale (16) has latching detente positions at 0o, 15°, 22.5o, 30o and 45o.
- Press down lightly on the handle (2), pull the retaining pin (15) out of the motor holder to disengage the saw from its bottom locked position.
- Raise the machine head (4) to the top working position.
- By adjusting the bevel lock lever (11), the machine head (4) can be beveled to the left up to 45o.
- Make sure the main voltage is compatible with your power source.

Figure 3

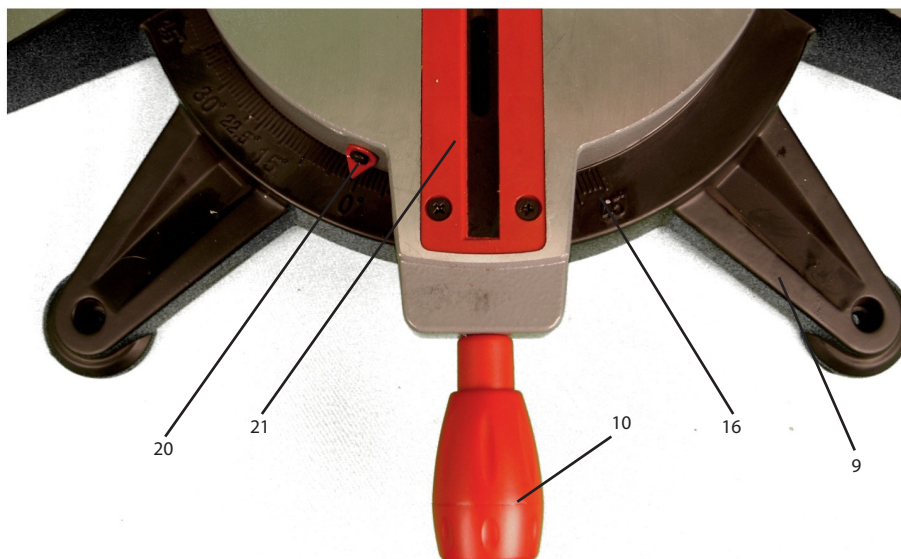

C. Precision adjustment of bevel scale at 90° (Fig. #4 & 5)

- Lower the machine head (4) and lock the saw in the down position with the retaining pin (15).
- Loosen the bevel lock lever (11).
- Place a speed square (not included) against the saw blade (5) and touching the saw table (8) at 90°.
- Loosen the 90° bevel nut (29) and adjust 90° bevel screw (30) until the angle between the saw blade (5) and the miter table (8) equals 90°.
- Re-tighten the bevel nut (29) to secure this setting.

Figure 4

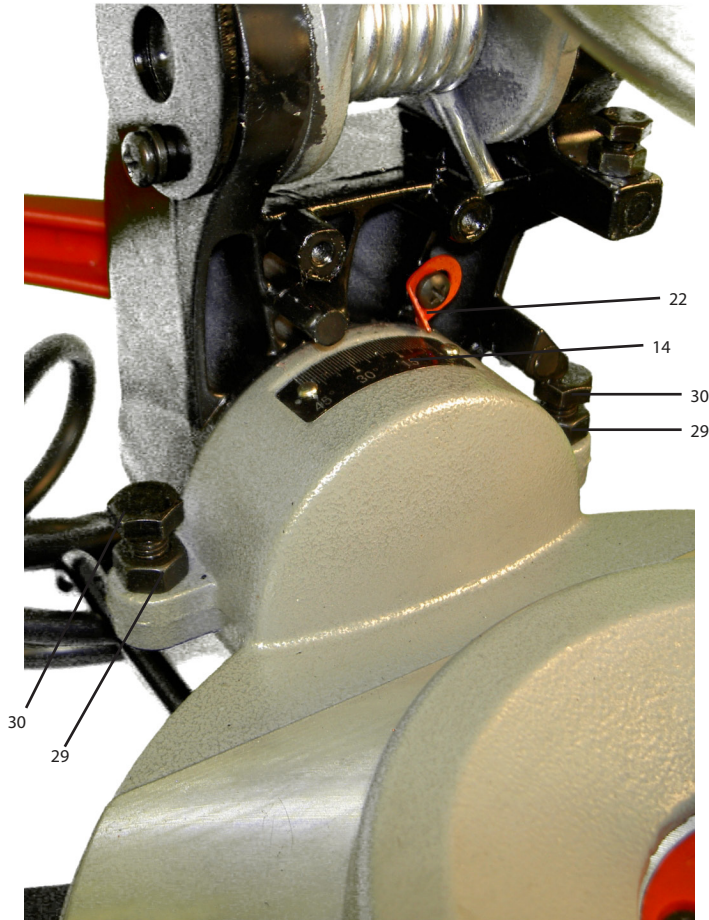
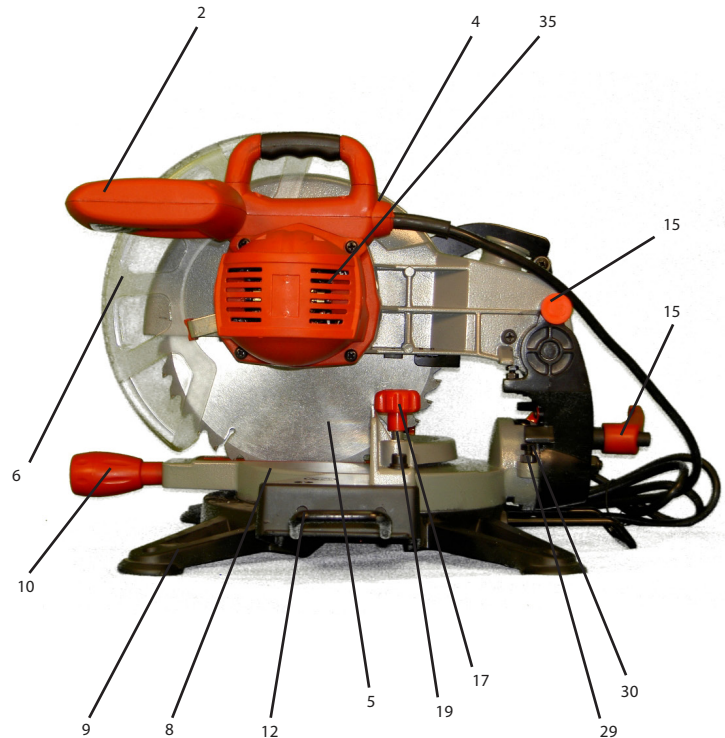

Figure 5



D. Precision adjustment of the stop for 45° bevel cuts (Fig. 1 & 4)

- Lower the machine head (4) and lock the saw in the down position with the retaining pin (15).
- Secure the miter table (8) in 0° position.
- Use the handle (2) to tilt the machine head (4) to the left until the bevel degree angle indicator (22) on the bevel scale (14) reads 45°.
- Place a speed square (not included) on the miter table (8) with the 45° slope (of the speed square) angling from left to right. Speed square must be flush against the saw blade (5) for accuracy.
- Loosen the 45° bevel nut (31) and adjust the 45° bevel screw (32) until the angle between the saw blade (5) and the miter table (8) equals exactly 45°.

E.) Dust bag (Fig. 2, 6, & 9)

The saw is equipped with a sawdust bag (13) to collect sawdust and chips. You can release the sawdust bag (13) from the sawdust exhaust port (33) by pressing together on the two clips. To empty the bag, unzip at the bottom.

F.) Replacing the saw blade (Fig. 1,7, & 9)

Remove the power cord from the power outlet!

- Raise the machine head (4) to top position.
- Unscrew the Blade Cover Plate screws (34) and flip the cover plate up together with the saw blade guard (6).
- Press the blade lock (1) with one hand while holding the Phillips headed hex wrench (25) on the flange bolt (not pictured) with the other.
- Firmly press on the blade lock (1) and slowly rotate the flange bolt (not pictured) in clockwise direction. The blade lock (1) engages after no more than one rotation.
- Now, using a little more force, loosen the flange bolt (not pictured) in clockwise direction.
- Turn the flange bolt (not pictured) until it is completely removed.
- Take the saw blade (5) off the inner flange and pull out downwards.
- Mount the new saw blade (5) in reverse order and fasten.

Important! The cutting bevel of the teeth, i.e. the direction of rotation of the saw blade (5), has to conform with the direction of the arrow marked on the housing.

- Clean the saw blade flanges thoroughly before mounting the replacement saw blade (5).
- Reattach the movable blade guard (6) in reverse order.
- Before using the saw again, check that the safety devices are in good working order.

Important! Every time that you change the saw blade (5), check to see that it spins freely in the groove of the turntable in both perpendicular and 45° angle settings.

Figure 6

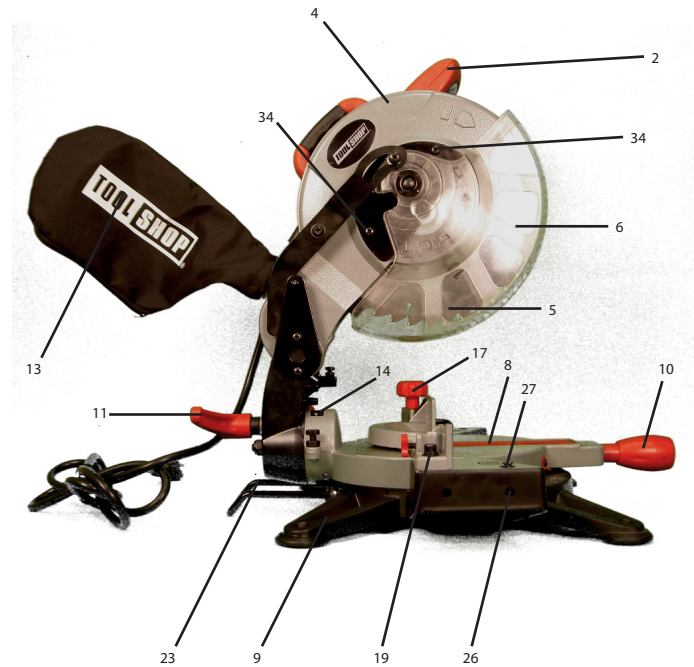
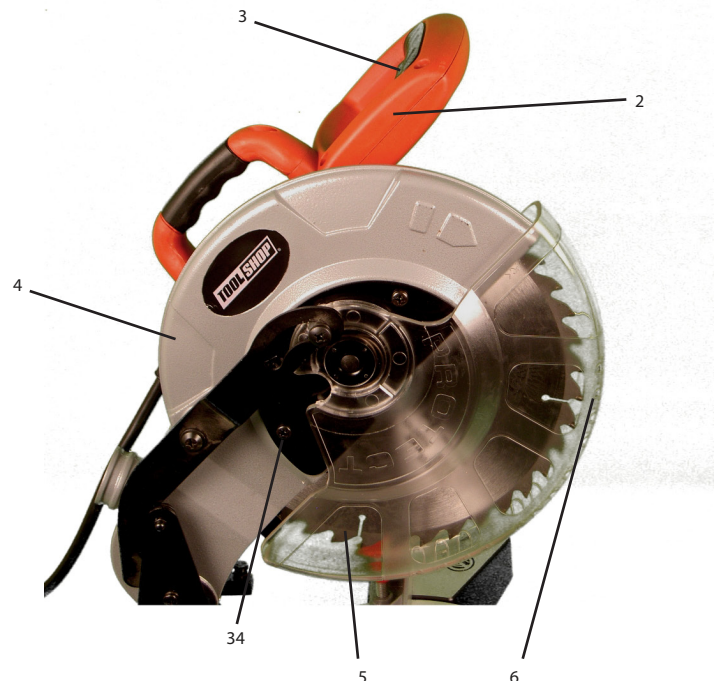

Figure 7



SAW OPERATIONS (Fig. 1, 3, 4 & 8)

A. Chop-cuts

- To turn on the machine, squeeze the on/off switch (3) located in the handle (2).

Important! To cut, place the material flat on the machine surface and secure with the material hold down clamp (18) so that the material cannot move while you are cutting.

- After turning on the saw, wait for the blade (5) to reach its maximum speed.
- Using the handle (2), apply steady and light downward pressure to move the machine head (4) through the workpiece.
- When the cut is completed, return the machine to its top position and let go of the On/Off switch (3).

Caution! A return spring causes the machine head (4) to rise automatically at the end of the cut. Do not let go of handle (2) as soon as the cut is completed. Steady the machine head (4) and allow it to rise slowly.

B. Miter Cuts

The saw can be used to make miter cuts of 0°-45° relative to the fence (7) on the left and right side.

- Turn the table (8) by moving miter table knob (10) to the desired degree.
- Make the cut as described in Section A of Saw Operations.

C. Bevel cuts

The saw can be used to make bevel cuts of 0°- 45° to the left.

- Lift the machine head (4) to its top position.
- Move the table (8) to the 0° position, and secure with miter lock knob (17).
- Loosen the bevel lock lever (11) and use the handle (2) to tilt the machine head (4) to the left until the bevel degree angle indicator (22) coincides with the desired angle number on the bevel scale (14).
- Make the cut as described in Section A of Saw Operations.

G. Compound Cuts

The saw can be used to make bevel cuts on the left at an angle of 0°-45° relative to the table (8), and miter cuts -45° /0°/ +45° relative to the fence (7).

- Lift the machine head (4) to its top position.
- Adjust the miter table (8) by its handle (2) to the required angle.
- Undo the bevel lock lever (11) and use the handle (2) to tilt the machine head (4) to the left until it coincides with the desired angle number on the bevel scale (14).
- Tighten the bevel lock lever (11).

Figure 8

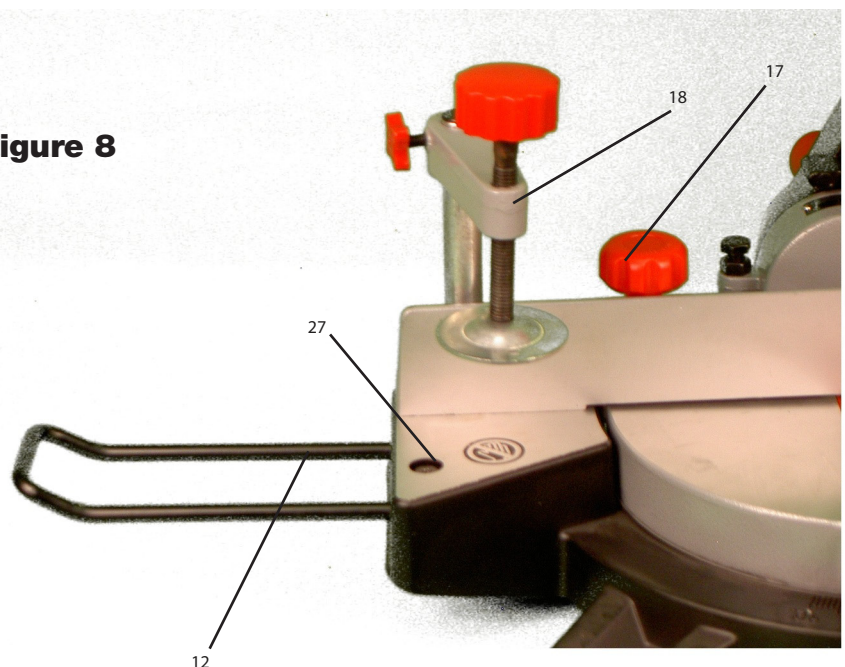

Maintenance

Inspect the cord regularly and have it replaced by an authorized repair facility if it is damaged.

- Check the brushes occasionally (after about 50 hours of use) and replace if worn. The brushes can be replaced by removing the motor back cap. The brushes and their springs could jump out of the holders- be careful not to lose them. Inspect the brushes. If the contact surface is not smooth, or it is worn or heavily used, replace both brushes. Insert the new brushes and springs in their holders and re-fasten the cap.
- The plastic kerf plate table insert should be replaced if damaged to reduce the risk of chips lodging in the slot and catching in the blade.
- Keep the vents clear of dust and debris. This will help prevent possible electrical shorts and ensure proper cooling.
- Keep the tool housing and handle clean and free of oil and grease by using mild soap and a damp (not wet) cloth.

TOOL SHOP® 10” COMPOUND MITER SAW WARRANTY

1-YEAR LIMITED WARRANTY:

This TOOL SHOP® brand power tool carries a 1-Year Limited Warranty to the original purchaser. If, during normal use, this TOOL SHOP® tool fails due to a defect in material or workmanship within one (1) year from the date of purchase, simply bring this tool with your original sales receipt back to your nearest MENARDS® retail store. At its discretion, TOOL SHOP® agrees to have the tool replaced with the same or similar TOOL SHOP® product free of charge, within the stated warranty period, when returned by the original purchaser with original sales receipt. Notwithstanding the foregoing, this limited warranty does not cover any damage that has resulted from abuse or misuse of the Merchandise. This warranty: (1) excludes expendable parts including but not limited to blades, belts, bits, light bulbs, and/or batteries; (2) shall be void if this tool is used for commercial and/or rental purposes; and (3) does not cover any losses, injuries to persons/property or costs. This warranty does give you specific legal rights and you may have other rights, which vary from state to state. Be careful, tools are dangerous if improperly used or maintained. Seller’s employees are not qualified to advise you on the use of this Merchandise. Any oral representation(s) made will not be binding on seller or its employees. The rights under this limited warranty are to the original purchaser of the Merchandise and may not be transferred to any subsequent owner. This limited warranty is in lieu of all warranties, expressed or implied including warranties or merchantability and fitness for a particular purpose. Seller shall not be liable for any special, incidental, or consequential damages. The sole exclusive remedy against the seller will be for the replacement of any defects as provided herein, as long as the seller is willing or able to replace this product or is willing to refund the purchase price as provided above. For insurance purposes, seller is not allowed to demonstrate any of these power tools for you.

For questions / comments, technical assistance or repair parts –
Please call toll free at: 1-877-886-6822 (M-F 8am – 5pm CST)

**SAVE YOUR RECEIPTS.
THIS WARRANTY IS VOID WITHOUT THEM.**