

**MODEL W1668
13¹/₄" OSCILLATING
DRILL PRESS**



OWNER'S MANUAL

Phone: (360) 734-3482 • Online Technical Support: tech-support@shopfox.biz

COPYRIGHT ©2000 BY WOODSTOCK INTERNATIONAL, INC. REVISED APRIL, 2008 (BL)

WARNING: NO PORTION OF THIS MANUAL MAY BE REPRODUCED IN ANY SHAPE OR FORM WITHOUT

THE WRITTEN APPROVAL OF WOODSTOCK INTERNATIONAL, INC.



WARNING!

This manual provides critical safety instructions on the proper setup, operation, maintenance and service of this machine/equipment.

Failure to read, understand and follow the instructions given in this manual may result in serious personal injury, including amputation, electrocution or death.

The owner of this machine/equipment is solely responsible for its safe use. This responsibility includes but is not limited to proper installation in a safe environment, personnel training and usage authorization, proper inspection and maintenance, manual availability and comprehension, application of safety devices, blade/cutter integrity, and the usage of personal protective equipment.

The manufacturer will not be held liable for injury or property damage from negligence, improper training, machine modifications or misuse.



WARNING!

Some dust created by power sanding, sawing, grinding, drilling, and other construction activities contains chemicals known to the State of California to cause cancer, birth defects or other reproductive harm. Some examples of these chemicals are:

- Lead from lead-based paints.
- Crystalline silica from bricks, cement and other masonry products.
- Arsenic and chromium from chemically-treated lumber.

Your risk from these exposures varies, depending on how often you do this type of work. To reduce your exposure to these chemicals: Work in a well ventilated area, and work with approved safety equipment, such as those dust masks that are specially designed to filter out microscopic particles.

CONTENTS

INTRODUCTION	2	OPERATIONS	23
Woodstock Technical Support	2	Drill Press.....	23
Specifications	3	Drill/Drum Changes.....	24
SAFETY	4	Using the Oscillator.....	25
Standard Safety Instructions	4	MAINTENANCE	27
Additional Safety for Drill Presses.....	6	General	27
Avoiding Potential Injuries.....	7	Lubrication	27
ELECTRICAL	8	Table and Base.....	27
110V Operation	8	Sanding Sleeves.....	27
Extension Cords	8	Troubleshooting.....	28
Electrical Specifications	8	Wiring Diagram	29
SETUP	9	Drill Press Accessories	30
Unpacking	9	PARTS	32
Inventory	9	W1668 Parts Breakdown	32
Base and Column.....	10	Parts List.....	33
Dust Port.....	10	Warranty Registration	35
Table Support	11	WARRANTY	37
Table	12		
Headstock	13		
Drill Chuck.....	14		
Handles	14		
ADJUSTMENTS	15		
Belt Tension	15		
Feed Shaft Spring Tension	16		
Quill-Shaft Screw.....	17		
Table Height and Tilt	18		
Drilling Speed.....	19		
Drill Press RPM Chart	20		
Drilling Depth.....	20		





INTRODUCTION

Woodstock Technical Support

This machine has been specially designed to provide many years of trouble-free service. Close attention to detail, ruggedly built parts and a rigid quality control program assure safe and reliable operation.

Woodstock International, Inc. is committed to customer satisfaction. Our intent with this manual is to include the basic information for safety, setup, operation, maintenance, and service of this product.

We stand behind our machines! In the event that questions arise about your machine, please contact Woodstock International Technical Support at (360) 734-3482 or send e-mail to: tech-support@shopfox.biz. Our knowledgeable staff will help you troubleshoot problems and process warranty claims.

If you need the latest edition of this manual, you can download it from <http://www.shopfox.biz>.

If you have comments about this manual, please contact us at:

Woodstock International, Inc.
Attn: Technical Documentation Manager
P.O. Box 2309
Bellingham, WA 98227
Email: manuals@woodstockint.com

Specifications

Motor Type:	TEFC Capacitor Start Induction
Motor:	³ / ₄ HP, 110V, 9 Amp., Single Phase / 60 Hz
RPM:	1725
Power Transfer:	V-Belt Drive
Bearings:	Shielded & Lubricated Ball Bearings
Switch:	Toggle ON/OFF Switch, W/ Safety Lock Tab
Oscillating Stroke Length:	³ / ₄ "
Spindle Travel:	3 ¹ / ₄ "
Maximum Distance, Spindle to Base:	24"
Maximum Distance, Spindle to Table:	17 ¹ / ₄ "
Overall Height:	38"
Dust Port Size:	2 ¹ / ₄ "
Spindle Taper:	JT-33
Table Swing:	13 ¹ / ₄ "
Table Tilt:	90°
Chuck Size:	⁵ / ₈ " (1-16mm JT-33), Keyed
Speeds:	12, Belt Controlled
Range of Speeds:	250, 330, 380, 500, 590, 640, 980, 1530, 1600, 1870, 2580, 3050 RPM
Drilling Capacity:	³ / ₄ " Diameter in Steel
Approximate Shipping Weight:	130 lbs.

SAFETY

**READ MANUAL BEFORE OPERATING MACHINE.
FAILURE TO FOLLOW INSTRUCTIONS BELOW WILL
RESULT IN PERSONAL INJURY.**

DANGER

Indicates an imminently hazardous situation which, if not avoided, WILL result in death or serious injury.

WARNING

Indicates a potentially hazardous situation which, if not avoided, COULD result in death or serious injury.

CAUTION

Indicates a potentially hazardous situation which, if not avoided, MAY result in minor or moderate injury.

NOTICE

This symbol is used to alert the user to useful information about proper operation of the equipment, and/or a situation that may cause damage to the machinery.

Standard Safety Instructions

1. **READ THROUGH THE ENTIRE MANUAL BEFORE STARTING MACHINERY.** Machinery presents serious injury hazards to untrained users.
2. **ALWAYS USE ANSI APPROVED SAFETY GLASSES WHEN OPERATING MACHINERY.** Everyday eye-glasses only have impact resistant lenses—they are NOT safety glasses.
3. **ALWAYS WEAR A NIOSH APPROVED RESPIRATOR WHEN OPERATING MACHINERY THAT PRODUCES DUST.** Wood dust is a carcinogen and can cause cancer and severe respiratory illnesses.
4. **ALWAYS USE HEARING PROTECTION WHEN OPERATING MACHINERY.** Machinery noise can cause permanent hearing damage.
5. **WEAR PROPER APPAREL.** DO NOT wear loose clothing, gloves, neckties, rings, or jewelry which may get caught in moving parts. Wear protective hair covering to contain long hair and wear non-slip footwear.
6. **NEVER OPERATE MACHINERY WHEN TIRED, OR UNDER THE INFLUENCE OF DRUGS OR ALCOHOL.** Be mentally alert at all times when running machinery.
7. **ONLY ALLOW TRAINED AND PROPERLY SUPERVISED PERSONNEL TO OPERATE MACHINERY.** Make sure operation instructions are safe and clearly understood.
8. **KEEP CHILDREN AND VISITORS AWAY.** Keep all children and visitors a safe distance from the work area.
9. **MAKE WORKSHOP CHILD PROOF.** Use padlocks, master switches, and remove start switch keys.

10. **NEVER LEAVE WHEN MACHINE IS RUNNING.** Turn power **OFF** and allow all moving parts to come to a complete stop before leaving machine unattended.
11. **DO NOT USE IN DANGEROUS ENVIRONMENTS.** DO NOT use machinery in damp, wet locations, or where any flammable or noxious fumes may exist.
12. **KEEP WORK AREA CLEAN AND WELL LIT.** Clutter and dark shadows may cause accidents.
13. **USE A GROUNDED EXTENSION CORD RATED FOR THE MACHINE AMPERAGE.** Undersized cords overheat and lose power. Replace extension cords if they become damaged. DO NOT use extension cords for 220V machinery.
14. **ALWAYS DISCONNECT FROM POWER SOURCE BEFORE SERVICING MACHINERY.** Make sure switch is in OFF position before reconnecting.
15. **MAINTAIN MACHINERY WITH CARE.** Keep blades sharp and clean for best and safest performance. Follow instructions for lubricating and changing accessories.
16. **MAKE SURE GUARDS ARE IN PLACE AND WORK CORRECTLY BEFORE USING MACHINERY.**
17. **REMOVE ADJUSTING KEYS AND WRENCHES.** Make a habit of checking for keys and adjusting wrenches before turning machinery **ON**.
18. **CHECK FOR DAMAGED PARTS BEFORE USING MACHINERY.** Check for binding and alignment of parts, broken parts, part mounting, loose bolts, and any other conditions that may affect machine operation. Repair or replace damaged parts.
19. **USE RECOMMENDED ACCESSORIES.** Refer to the instruction manual for recommended accessories. The use of improper accessories may cause risk of injury.
20. **DO NOT FORCE MACHINERY.** Work at the speed for which the machine or accessory was designed.
21. **SECURE WORKPIECE.** Use clamps or a vise to hold the workpiece when practical. A secured workpiece protects your hands and frees both hands to operate the machine.
22. **DO NOT OVERREACH.** Keep proper footing and balance at all times.
23. **MANY MACHINES WILL EJECT THE WORKPIECE TOWARD THE OPERATOR.** Know and avoid conditions that cause the workpiece to "kickback."
24. **ALWAYS LOCK MOBILE BASES (IF USED) BEFORE OPERATING MACHINERY.**
25. **BE AWARE THAT CERTAIN DUST MAY BE HAZARDOUS** to the respiratory systems of people and animals, especially fine dust. Make sure you know the hazards associated with the type of dust you will be exposed to and always wear a respirator approved for that type of dust.

Additional Safety for Drill Presses

SAFETY



! WARNING
 READ and understand this entire instruction manual before using this machine. Serious personal injury may occur if safety and operational information is not understood and followed. **DO NOT** risk your safety by not reading!

! CAUTION
 USE this and other machinery with caution and respect. Always consider safety first, as it applies to your individual working conditions. No list of safety guidelines can be complete—every shop environment is different. Failure to follow guidelines could result in serious personal injury, damage to equipment or poor work results.

1. **EYE/FACE/HAND PROTECTION.** A face shield used with safety glasses is recommended. Always keep hands and fingers away from the drill bit. Never hold a workpiece by hand while drilling! **DO NOT** wear gloves when operating the drill.
2. **SECURING BIT.** Properly tighten and securely lock the drill bit in the chuck.
3. **CORRECT BIT.** Use only round, hex, or triangular shank drill bits.
4. **ADJUSTING KEYS AND WRENCHES.** Remove all adjusting keys and wrenches before turning the machine ON.
5. **DRILLING SHEET METAL.** Never drill sheet metal unless it is securely clamped to the table.
6. **SURFACE/WORKPIECE PREP.** Never turn the drill press **ON** before clearing the table of all objects (tools, scrap wood, etc.) **DO NOT** drill material that does not have a flat surface, unless a suitable support is used.
7. **DAMAGED TOOLS.** Never use drill bits in poor condition. Dull or damaged drill bits are hard to control and may cause serious injury.
8. **DRILL OPERATION.** Never start the drill press with the drill bit pressed against the workpiece. Feed the drill bit evenly into the workpiece. Back the bit out frequently to clear deep holes.
9. **CLEARING CHIPS.** Turn the machine **OFF** and clear chips and scrap pieces with a brush. Disconnect power, remove drill bit, and clean table before leaving the machine.
10. **OPERATING SPEED.** Always operate your drill press at speeds that are appropriate for the drill bit size and the material that you are drilling.
11. **MOUNTING WORKPIECES.** Use clamps or vises to secure workpiece before drilling. Position work so you avoid drilling into the table.
12. **TABLE LOCK.** Make sure the table lock is tightened before starting the drill press.
13. **MAINTENANCE/SPEED CHANGES.** Never change speeds or do maintenance with the machine connected to power.
14. **EXPERIENCING DIFFICULTIES.** If at any time you are experiencing difficulties performing the intended operation, stop using the machine! Contact our Technical Support at (360) 734-3482.

Avoiding Potential Injuries

SAFETY

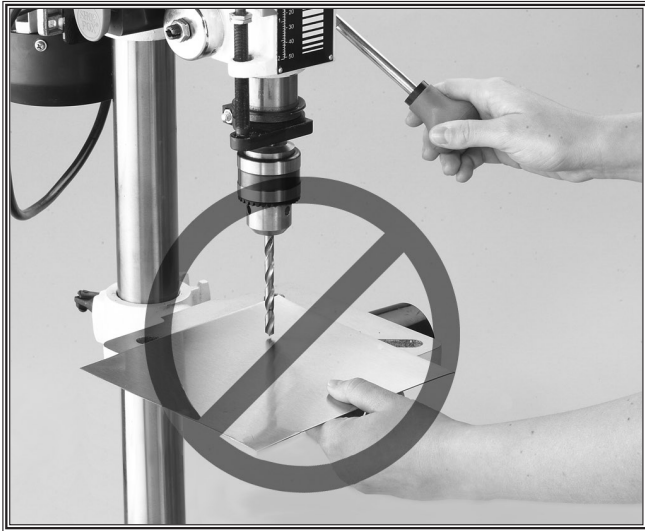

Figure 1. Never drill while holding the workpiece by hand.

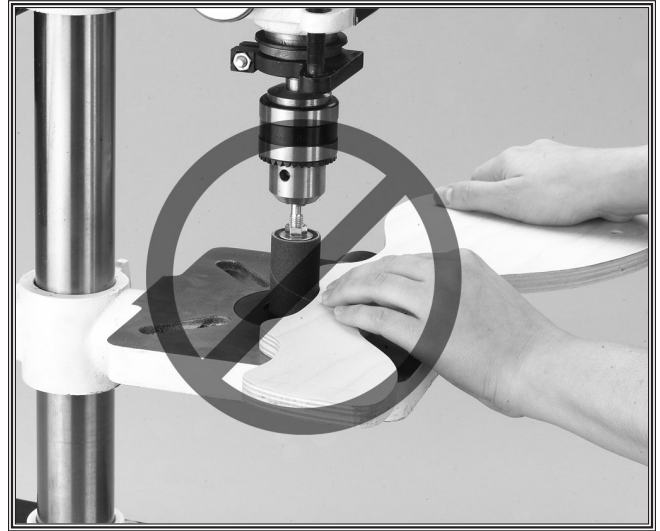

Figure 3. Keep fingers away from spinning drill bits, cutters, and sanding surfaces.

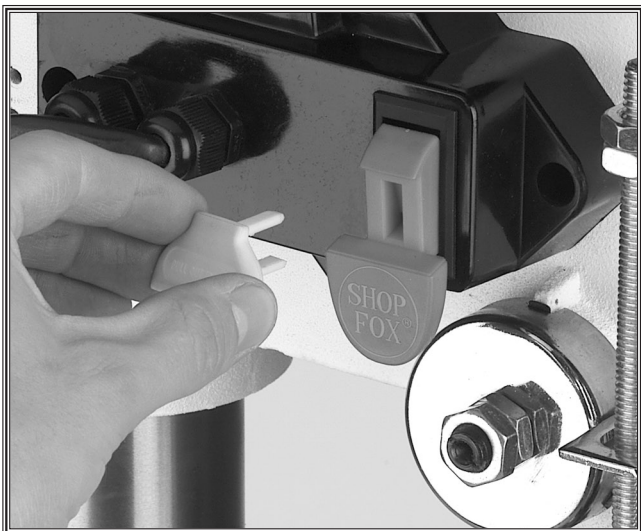

Figure 2. Remove switch safety key when not in use.

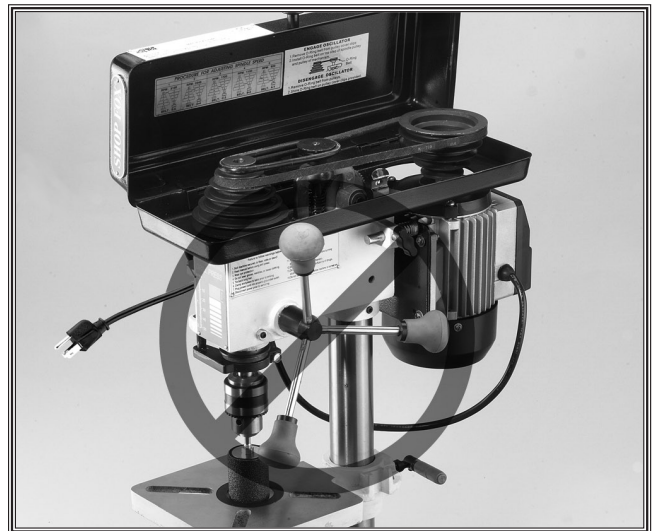

Figure 4. Remove handles when using the oscillating sanding feature.

ELECTRICAL

⚠️ WARNING

The machine must be properly set up before it is safe to operate. **DO NOT** connect this machine to the power source until instructed to do so in the "Test Run" portion of this manual.

110V Operation

The Model W1668 is wired for 110V operation. We recommend connecting this machine to a dedicated circuit with a verified ground, using the circuit size below as a minimum. Never replace a circuit breaker with one of higher amperage without consulting a qualified electrician to ensure compliance with wiring codes.

This machine must be grounded! The electrical cord supplied with this machine comes with a grounding pin. If your outlet does not accommodate a ground pin, have it replaced by a qualified electrician.

If you are unsure about the wiring codes in your area or you plan to connect your machine to a shared circuit, you may create a fire or circuit overload hazard—consult a qualified electrician to reduce this risk.

Extension Cords

We do not recommend using an extension cord; however, if you have no alternative, use the following guidelines:

- Use a cord rated for Standard Service (S).
- Do not use an extension cord longer than 50 feet.
- Ensure that the cord has a ground wire and pin.
- Use the gauge size listed below as a minimum.

Electrical Specifications

Operating Voltage	Amp Draw	Min. Circuit Size	Plug/Recommended Plug	Extension Cord
110V Operation	9 Amps	15A	NEMA 5-15	14 Gauge

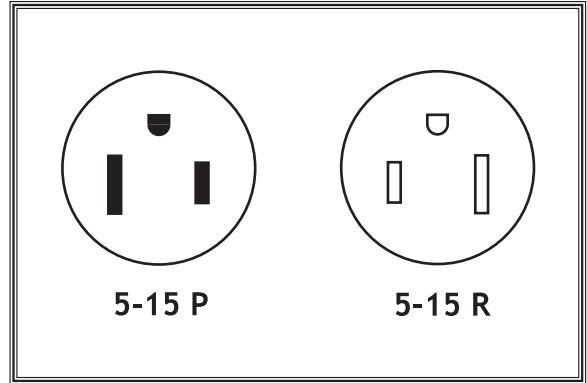

Figure 5. 5-15 plug and receptacle.

⚠️ WARNING



DO NOT work on your electrical system if you are unsure about electrical codes and wiring! Seek assistance from a qualified electrician. Ignoring this warning can cause electrocution, fire, or machine damage.

SETUP

Unpacking

This machine has been carefully packaged for safe transportation. If you notice the machine has been damaged during shipping, please contact your authorized Shop Fox dealer immediately.

Inventory

The following is a description of the main components shipped with the Model W1668. Lay the components out to inventory them.

Note: If you can't find an item on this list, check the mounting location on the machine or examine the packaging materials carefully. Occasionally we pre-install certain components for safer shipping.

Box Inventory (Figure 6 & 7)	Qty
A. Headstock Assembly.....	1
B. Table.....	1
C. Column.....	1
D. Rack.....	1
E. Table Bracket.....	1
F. Rack Ring.....	1
G. Base.....	1
H. Dust Port Halves.....	2
I. Table Inserts (5/8", 1", 1 3/8", 1 7/8").....	1ea
J. Sanding Mandrel.....	1
K. Spindle Handles.....	3
L. Hand.Crank.Handle.....	1
M. Hand Crank.....	1
N. Lock Handle M12-1.75.....	1
O. Lock Handle M10-1.5.....	1
P. Belt Cover Knob.....	1
Q. Key.....	1
R. Drill Chuck JT33.....	1
S. Pinion Gear.....	1
T. Spindle Sander Set D2877 (not shown).....	1

Tools and Fasteners (not shown)	Qty
–Special Wrench 25mm.....	1
–Open End Wrench 13 x 14.....	1
–Hex Wrenches 3, 4, 5mm.....	1ea
–Hex Nut M8-1.25 (Mandrel).....	1
–Mandrel Washers 3/4" OD x 5/8" ID (Mandrel).....	2
–Mandrel Washer 7/8" OD x 3/8" ID (Mandrel).....	1
–Mandrel Washer 5/8" OD x 3/8" ID (Mandrel).....	1
–Hex Bolt M10-1.5 x 25 (Colum/Base).....	4
–Phillips Head Screws M4-.7 x 22 (Dust Port).....	4
–Cap Screw M5-.8 x 20 (Chuck).....	1

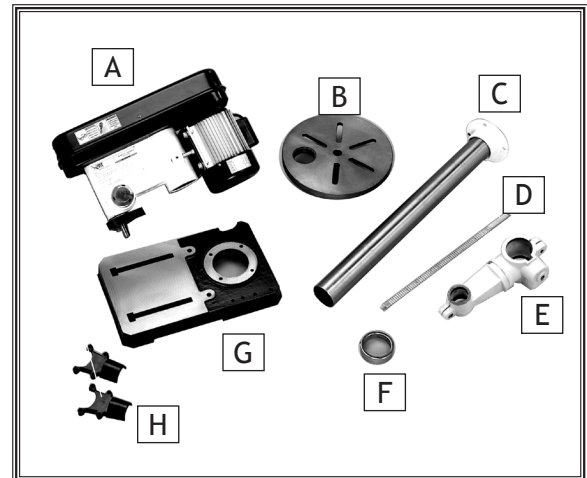
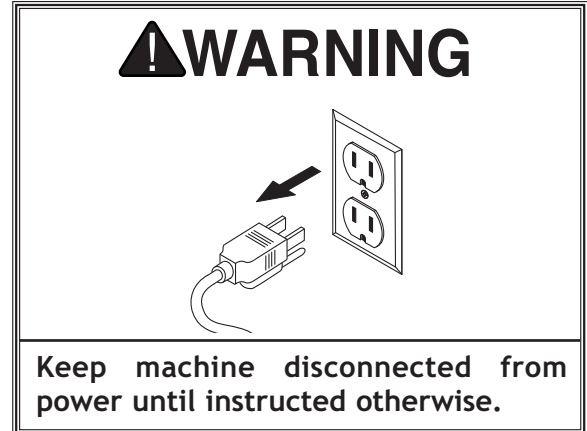

Figure 6. W1668 inventory.

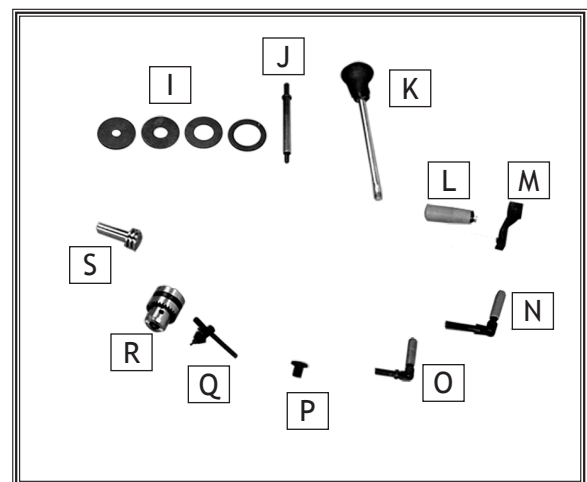

Figure 7. Additional W1668 inventory items.

SETUP

Base and Column

The base and column must be securely mounted, so the machine will not fall over.

To install the base and column, do these steps:

1. Position the drill press base on a flat and stable surface.
2. Using two clamps, clamp the base to the mounting surface.
3. Use the holes provided in the bottom of the base as a drill guide, and drill holes in the mounting surface (see **Figure 8**).
4. Secure the base with ⁵/₁₆" lag bolts or supplied through-bolts with washers and nuts.
5. Place the column on the base, line up the four mounting holes, and secure tightly with the four M10-1.5 x 25 hex bolts, using a 16mm wrench.



Figure 8. Using holes as a drill guide.



Figure 9. Installing the dust port.

Dust Port

The dust port directs suction to the sanding sleeve, removing hazardous dust and increasing abrasive life.

To install the dust port, do these steps:

1. Bring the dust port halves together, align the mounting holes on the dust port and table, then secure with the four M4-.7 x 22 Philips head screws, as shown in **Figure 9**.

Table Support

When secured to the column, the table support supports the table, provides smooth table height adjustment, and locks in position with firm lever torque. Additionally, when the table is rotated, the rack will slide with the table support.

To install the table support, do these steps:

1. Insert the 12mm lock handle into the table support bracket through the blind hole, into the threaded hole, and thread inward three turns, as shown in **Figure 10**.
2. If the pinion is not already installed, insert its shaft-end into the hole on the side of the table support bracket, as shown in **Figure 11**.
3. Align the set screw in the crank handle with the flat on the pinion shaft and tighten, as shown in **Figure 12**.
4. Thread the handle into the crank handle (**Figure 12**).
5. If the column ring is installed on the column, loosen the set screw on the ring and remove it.

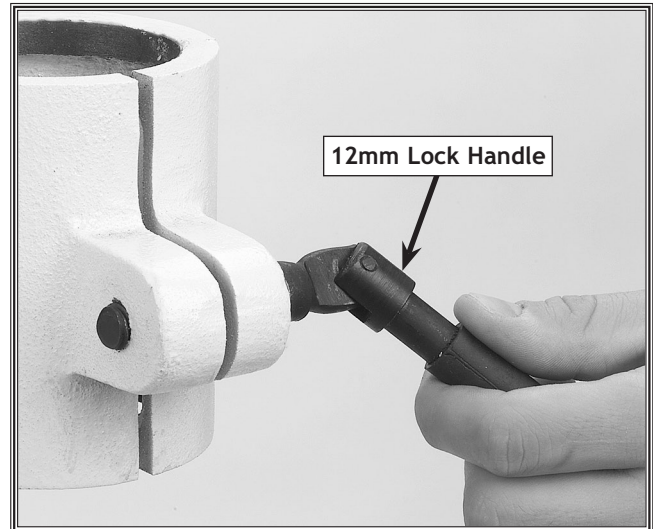

Figure 10. Loosely installing table lock lever.

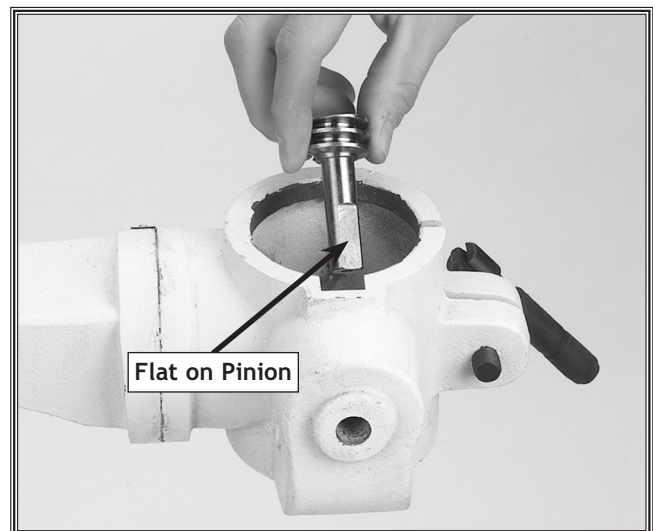

Figure 11. Pinion installation positioning.

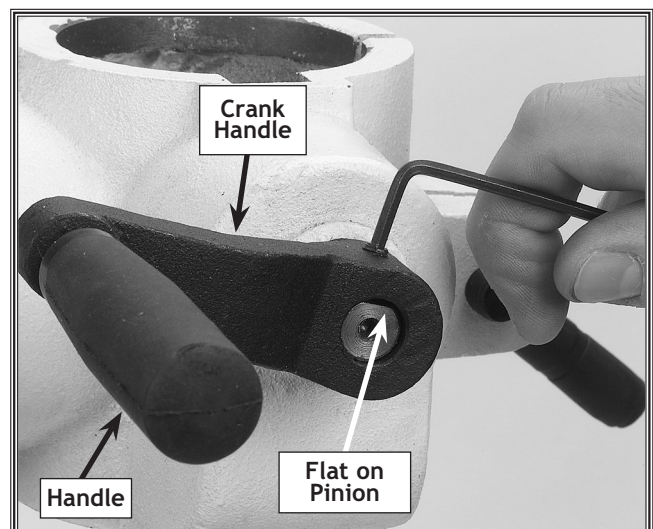

Figure 12. Crank and set screw positioning.

6. Position the rack so the long un-toothed end is facing upward (see **Figure 13**).
7. Insert the rack into the table support bracket so the teeth face out and mesh with the pinion (see **Figure 13**).
8. While holding the rack in place, slide the table support bracket onto the column.
9. Allow the bracket and rack to slide down until the bottom of the rack bevel slips into the tapered shoulder on the column support.
10. Slide the column ring onto the column with the inside bevel in the down position (see **Figure 14**).
11. Adjust the ring until the tip of the rack fits inside the bevel, and the rack rotates freely when you rotate the table support around the column.
12. Secure the table support with the table lock lever.

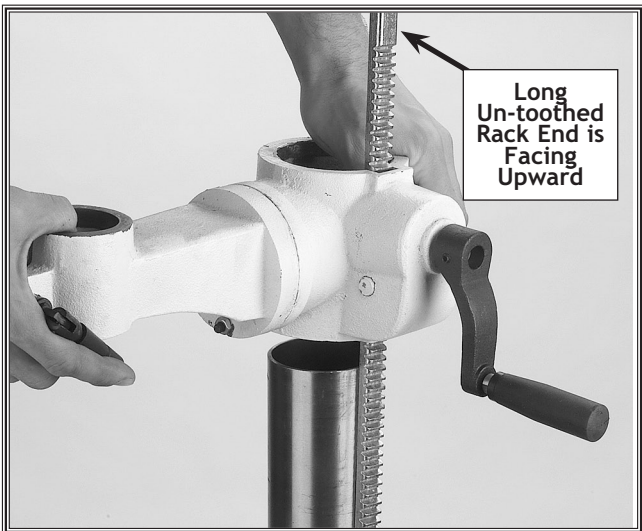

Figure 13. Rack, column, table support position.

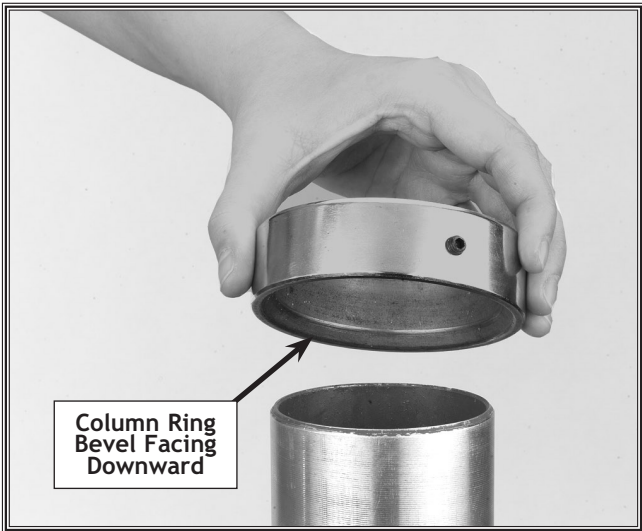

Figure 14. Column ring bevel positioning.

NOTICE

Use caution when tightening the set screw. Over tightening will split the column ring.

13. Carefully tighten the set screw on the ring.

Table

When installed correctly, the table should lock in position with firm lever torque.

To install the table, do these steps:

1. Thread the 10mm lock handle into the table bracket through the blind hole, into the threaded hole, and thread inward three turns.
2. Align the shaft under the table with the hole on the end of the table support bracket and install (see **Figure 15**).
3. Tighten the table lock lever.

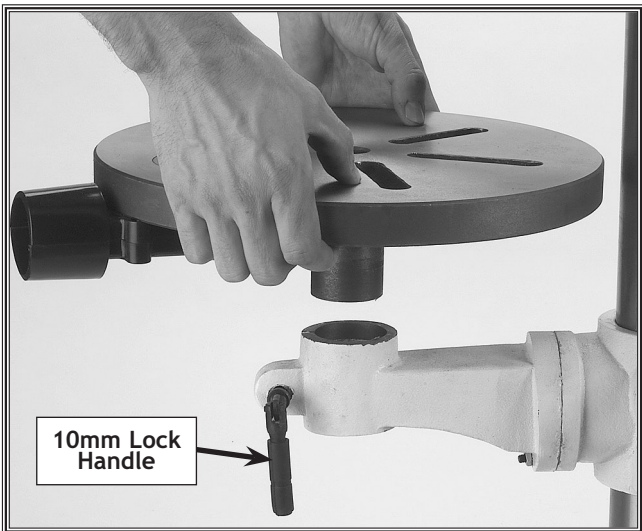
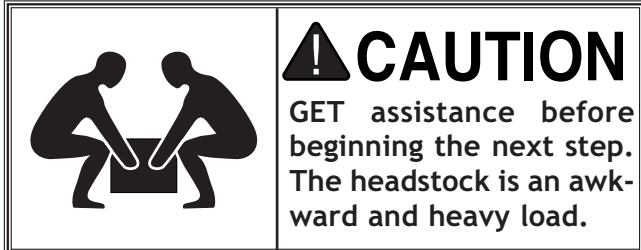

Figure 15. Table installation.

Headstock

The headstock must be tightened in position with two set screws, so the headstock is aligned with the drill press foot for balance and weight distribution. **DO NOT** over tighten the set screws and strip the threads or bend the column.



To install the headstock, do these steps:

1. With an assistant, position the pocket over the column (Figure 16) and allow the headstock to slide down until the column fully seats up and into the headstock (approximately 3¹/₂").

Tip: Place a few drops of multi-purpose grease on the column to help the headstock seat more easily.

2. Align the headstock directly over the foot of the base as viewed from the front of the drill press and center it using a plumb bob and ruler (see Figure 17).
3. Tighten the two set screws to secure the headstock to the column (see Figure 18).
4. Install the belt cover knob with the included Phillips head screw (see Figure 16).

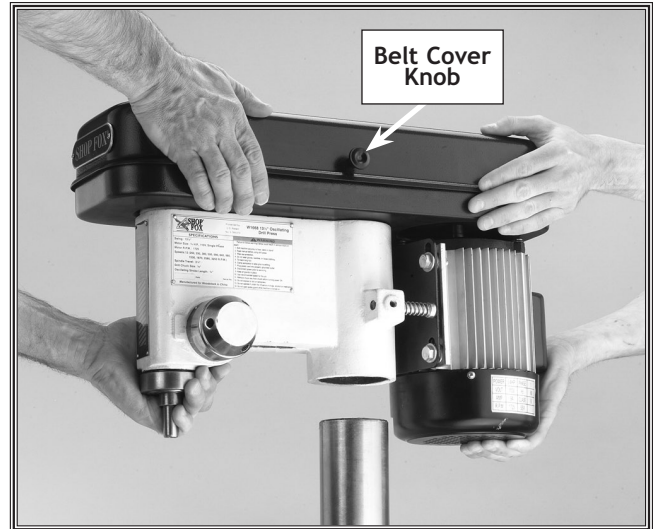

Figure 16. Aligning the pocket in the headstock with the column.



Figure 17. Aligning headstock with base.

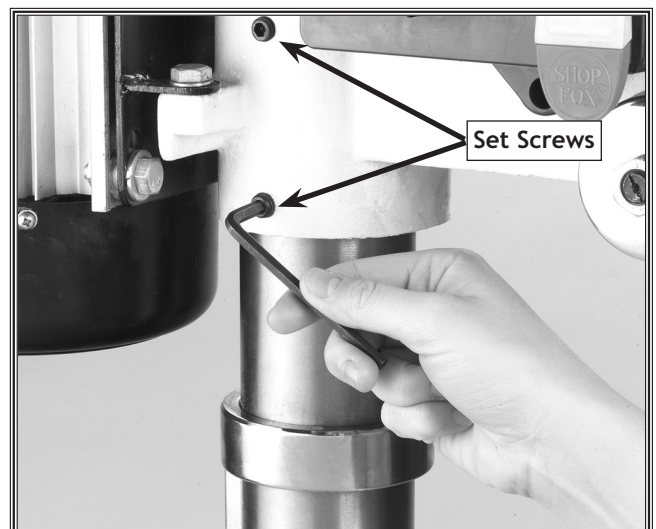

Figure 18. Securing the headstock to the column.

Drill Chuck

The drill chuck is seated to the spindle with a JT-33 tapered surface and a screw.

To install the drill chuck, do these steps:

1. Clean the drill chuck and spindle with mineral spirits and follow all safety warnings on the container. Failure to clean the tapered-mating surfaces of the spindle and drill chuck will result in the chuck falling off during use.
2. Use the provided chuck key to adjust the jaws of the chuck until they are well inside the drill chuck body (see **Figure 19**).

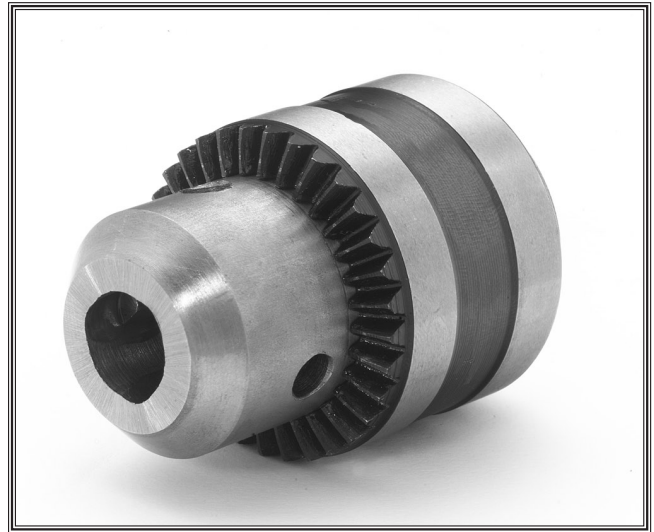

Figure 19. Jaws adjusted inside chuck body.

NOTICE

DO NOT use a hammer to seat the drill chuck onto the spindle. You will damage the oscillating mechanism.

3. Place the drill chuck on the spindle, and insert the capscrew into the hole of the drill chuck, as shown in **Figure 20**.
4. Tighten the screw so the drill chuck is seated securely on the spindle.
 - If the chuck fails to remain secure on the spindle, repeat **Step 1**, **DO NOT** use a hammer to seat the drill chuck onto the spindle!



Figure 20. Inserting the hex cap screw.

Handles

Three handles are supplied for drilling operations. **NOTE:** Remove these handles when you use the oscillating feature.

To install the handles, do these steps:

1. Thread the handles into the hub, as shown in **Figure 21**.
2. Tighten the handles with the included wrench until they are snug, **DO NOT** over-tighten.

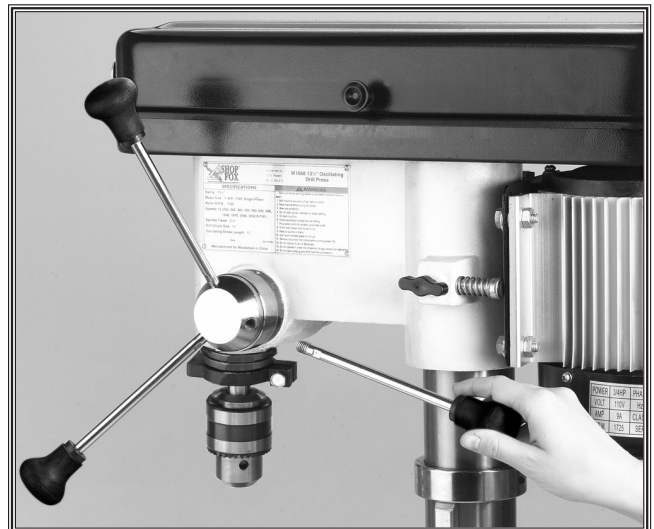

Figure 21. Installing spindle handles.

ADJUSTMENTS

Belt Tension

The drill press main drive belts last a long time; however, during machine life, a belt may stretch slightly which can cause the pulleys to slip under a load. You will then need to adjust the motor-to-idler pulley belt tension to compensate for this normal stretching.

NOTE: The spindle-to-idler pulley belt automatically adjusts to the correct tension when the motor-to-idler pulley belt tension is adjusted.

NOTICE

The oscillator belt is not adjustable. If the belt shows cracks or is slipping, replace the belt with a new one.



To adjust the drive belt tension, do these steps:

1. UNPLUG THE DRILL PRESS!
2. Open the belt cover.
3. Loosen the motor lock screw at the side of the headstock, as shown in **Figure 22**.
4. Gently pivot the motor away from the push rod rubber until the belt is tight.
5. Hold the motor in position so the rubber pad is held against the motor.
6. Tighten the lock screw, and make sure the belt deflection gap is correct when pinched together between the pulleys (see **Figure 23**).
 - If the gap between both inner sides of the belt is greater or less than 1¹/₂", repeat **Steps 3** through **6** until the deflection gap is 1¹/₂".

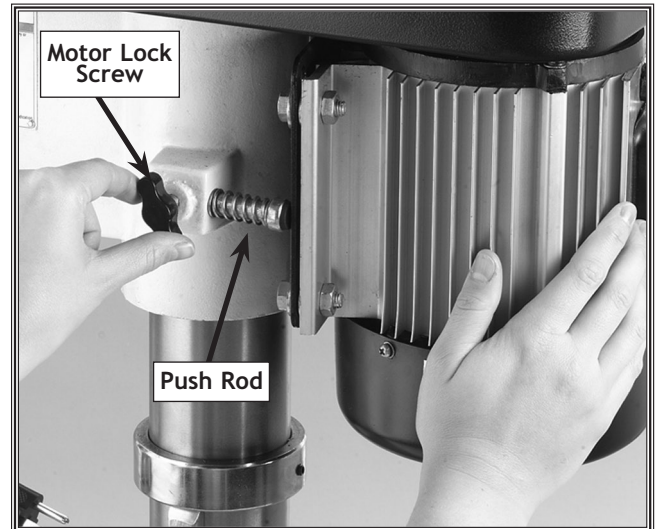

Figure 22. Motor lock screw.

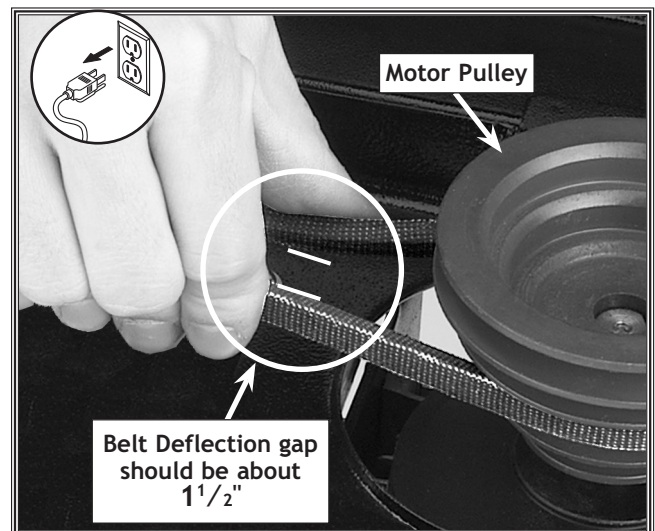

Figure 23. Measuring belt deflection.

Feed Shaft Spring Tension

The feed shaft return spring is adjusted at the factory; however, during the life of the drill press you may want to adjust the feed shaft return spring to a stronger return pressure.



! WARNING
MAKE SURE your machine is unplugged during all assembly, adjustments, or maintenance procedures. Otherwise serious personal injury may occur!



! WARNING
WEAR safety glasses when adjusting springs. Serious injury may occur if this warning is ignored!

To adjust the feed shaft spring tension, do these steps:

1. **UNPLUG THE DRILL PRESS!**
2. Wipe off any oil on the spring lock cover so it will not slip in your fingers when you hold the cover from spinning (see **Figure 24**).
3. Rotate the oscillator pulley so the depth stop reads "0" and the quill shaft is completely seated, as shown in **Figure 25**.
4. Put on thick leather gloves and hold the spring cover against the side of the head-stock, so the cover stays splined with the locking lug, and remove the jam nut to loosen the cover nut approximately 1/4" (6.4mm).
5. Pull the cover outward just enough to disengage the spring-cover lock slot from the locking lug (see **Figure 26**).
6. Rotate the cover counterclockwise to increase spring tension, or let the cover slowly unwind in the clockwise direction to reduce spring tension (see **Figure 26**).

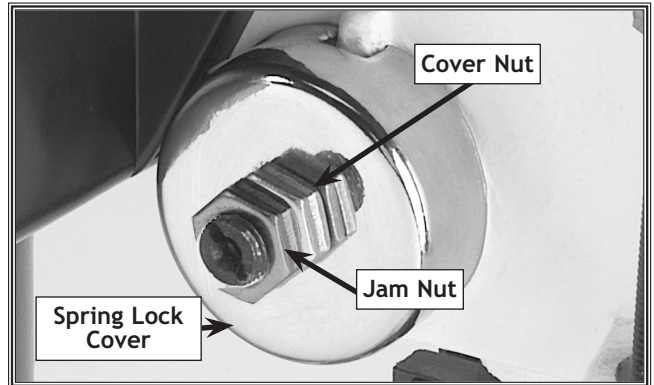

Figure 24. Typical feed shaft return spring assy.

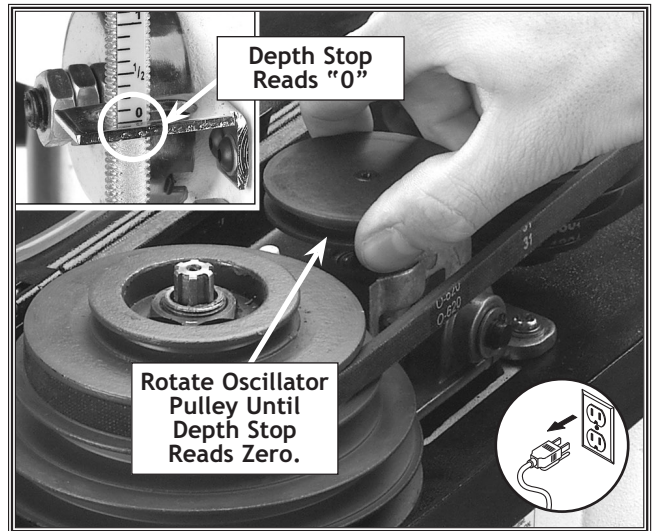

Figure 25. Fully seating quill shaft.

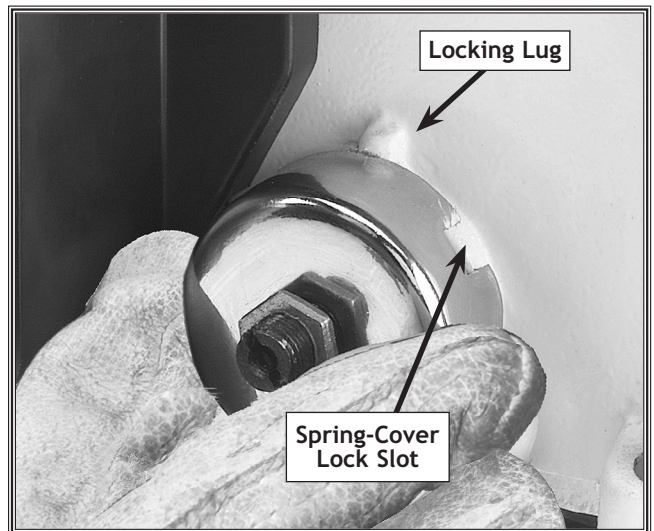

Figure 26. Typical spring cover lock slot and locking lug.

ADJUSTMENTS

7. Engage the next available spring-cover lock slot with the locking lug, and hold the spring lock cover tightly against the side of the headstock (see **Figure 27**).
8. Snug the cover nut against the spring cover just until the nut stops, and then back-off the nut approximately $\frac{1}{3}$ turn, or just enough so there is no binding anywhere along complete spindle travel.
9. Hold the cover nut and tighten the jam nut against the cover nut (see **Figure 27**).

Quill-Shaft Screw

While you may never have to adjust the quill shaft screw, you should understand its function and know how to adjust it should you ever need to remove the quill for cleaning. This screw prevents the quill from rotating during drilling and sanding procedures, and if adjusted incorrectly, the quill may have lash or bind.

	<p>⚠ WARNING UNPLUG your machine during all assembly, adjustments, and maintenance procedures. Otherwise serious personal injury may occur!</p>
--	--

To adjust the quill-shaft screw, do these steps:

1. **UNPLUG THE DRILL PRESS!**
2. Clean and lubricate the quill shaft with a thin coat of light oil, and make sure the quill travels freely (see **Figure 28**).
3. Loosen the jam nut shown in **Figure 29**.
4. Turn the quill shaft screw clockwise or counterclockwise to establish free, unbinding travel while moving the quill up and down through its entire range of travel.
5. When the quill shaft screw is screwed inward against the quill as far as the screw can go without binding the quill, hold the screw and tighten the jam nut.
6. Recheck for quill binding and looseness while moving the quill up and down through its entire range of travel and readjust as required.

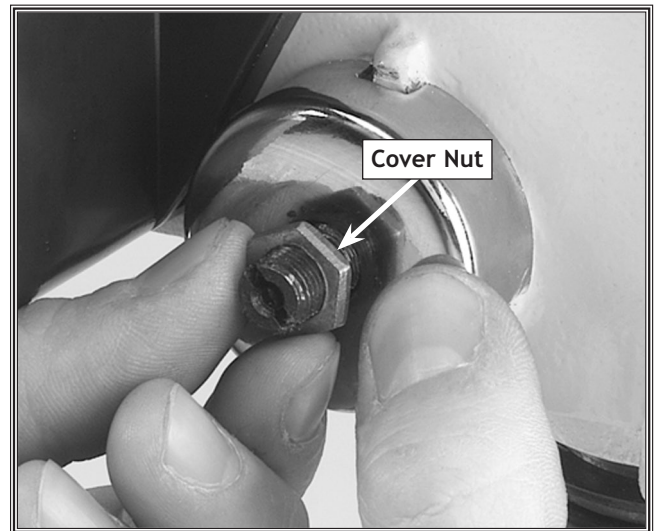

Figure 27. Hold the spring cover tightly.



Figure 28. Clean and oil quill shaft.

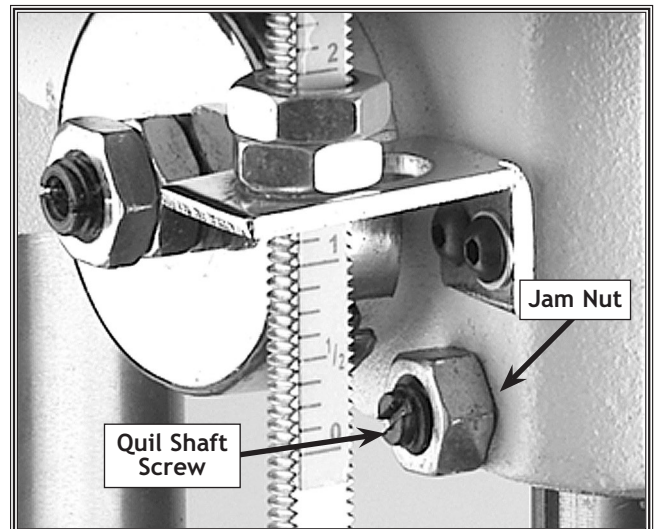

Figure 29. Typical quill-shaft screw and jam nut.

Table Height and Tilt

You can adjust the table height and tilt to accommodate for workpiece height or achieve special drilling/sanding angles. You can also move the table out of the way and use the drill press base as a table for drilling/sanding.

To adjust the table, do these steps:

1. Loosen the table lock lever.
2. Turn the hand crank to raise or lower the table, as shown in **Figure 30**.
3. Position the table so the opening in the installed table insert is centered to the drill bit or sanding drum.
 - If the table is not needed, pivot the table to the back side of the column (**Figure 31**) so you can support the workpiece on the base (**drilling operations only**).
4. Tighten the table lock lever.
5. Loosen the table tilt lock bolt.
6. Turn the index pin jam nut clockwise and draw the index pin out of the casting until you can rotate the table to your desired angle, and use the tilt scale to find your desired drilling or sanding angle (see **Figure 32**).

NOTE: Use this index pin only for indexing the table in the “Zero degree” position. (To index the table back to the zero position, turn the table to zero, tap the index pin back into the casting, snug the index pin jam nut, and tighten the table tilt lock bolt.)

7. Tighten the tilt table lock bolt, and double check your angle.

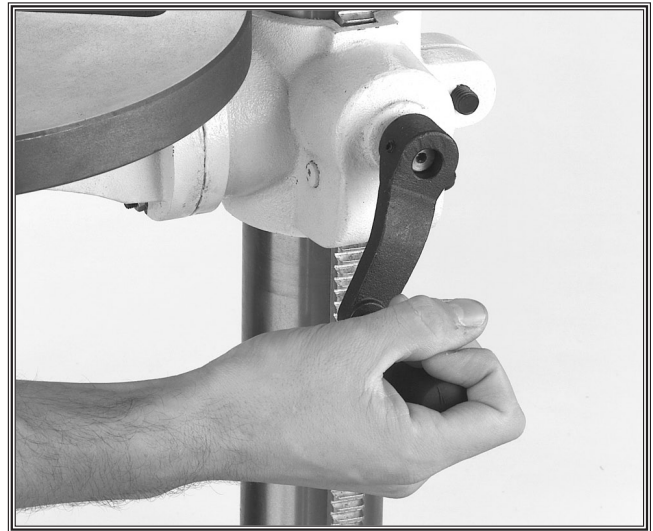

Figure 30. Raise or lower the table.

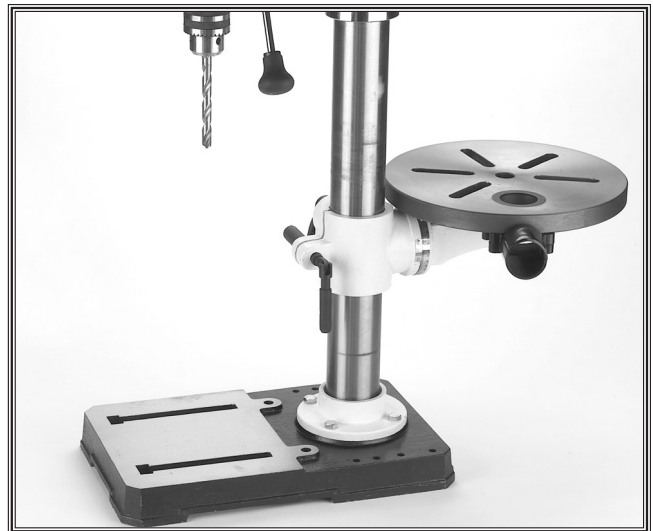

Figure 31. Table adjusted behind column.

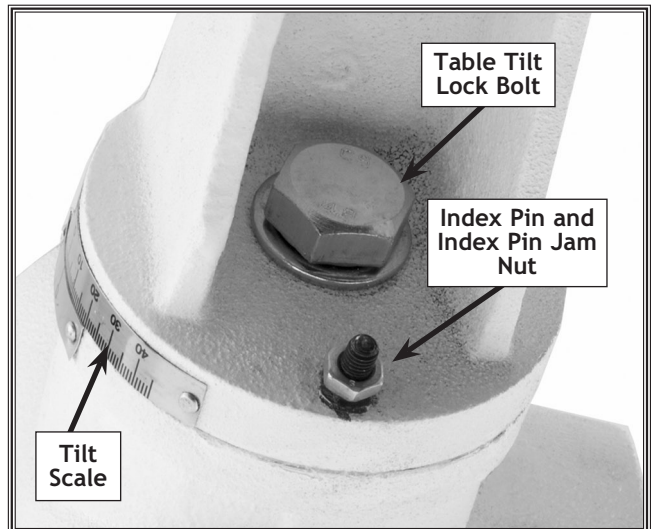
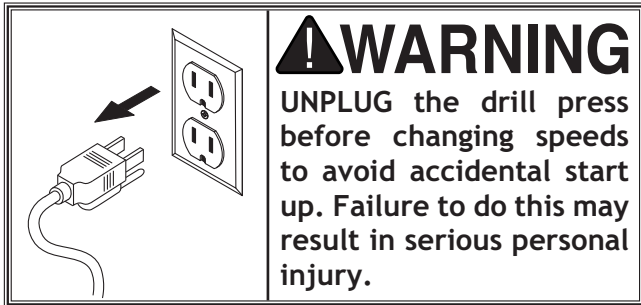

Figure 32. Table tilt lock bolt.

ADJUSTMENTS

Drilling Speed

The Model W1668 13 1/4" Oscillating Drill Press has 12 speeds ranging from 250 to 3050 RPM. Refer to the speed charts located under the belt guard while following the instructions below.



To change the drilling speed, do these steps:

1. UNPLUG THE DRILL PRESS!
2. Refer to the speed chart located under the belt cover or refer to the "Drill Press RPM Chart" on Page 20, and choose the desired speed.
3. Loosen the motor lock screw (see Figure 33).
4. Pull the motor toward the front of the drill press to remove tension from the V-belt.
5. Move the V-belt to the desired V-grooves on the motor and spindle pulleys (see Figure 34).
6. Push the motor toward the back of the headstock; the push rod is spring loaded and will follow the motor (see Figure 33).
7. Tighten the lock screw, and make sure the belt deflection is 1 1/2" between both inner sides when the belt is pinched together between the pulleys, as shown in Figure 35. Refer to "Belt Tension" in the ADJUSTMENTS section on Page 15 for details.
8. Close the cover. The motor will not start until the cover is closed.

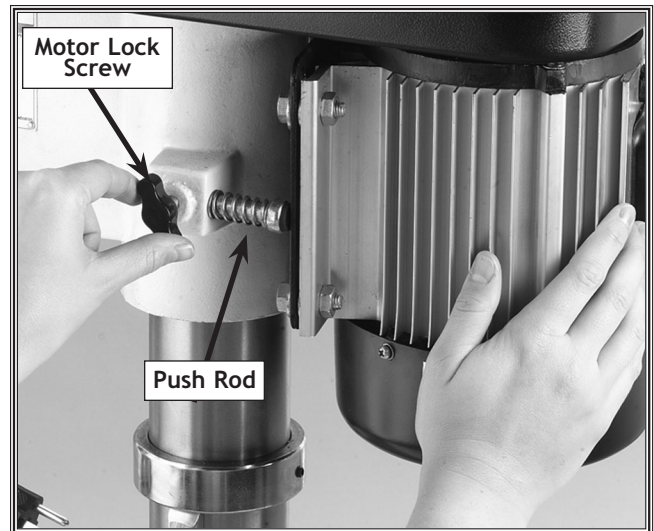

Figure 33. Loosening the lock knob.

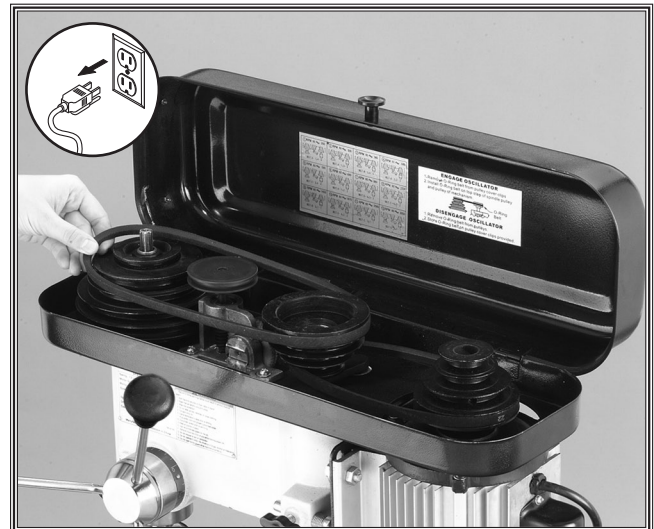

Figure 34. Adjusting belt to desired speed.

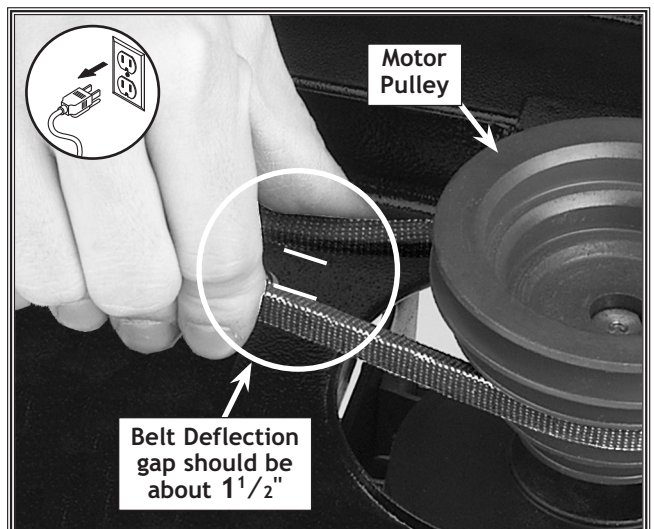

Figure 35. Measuring belt deflection.

Drill Press RPM Chart

Use **Figure 35** to select the optimum motor-to-spindle pulley ratio for drilling, cutting, and sanding operations. The belt setting in the example in **Figure 36** shows the spindle belt in the #1 spindle pulley position and the motor belt in the #7 motor pulley location. This will produce a speed of 1,870 RPM. Refer to the **Drill, Cutter, and Saw RPM Chart on Page 21** for suggested tool RPMs.

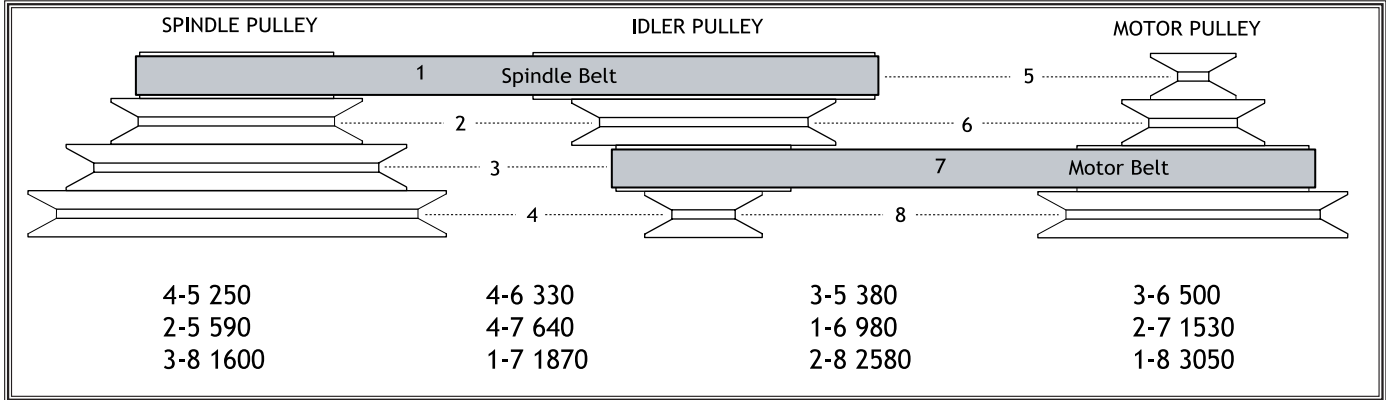

Figure 36. Drill Press RPM Chart.

Drilling Depth

Your new drill press comes fitted with a depth stop that allows drilling holes at a preset depth.

NOTICE

BACK-OFF the depth stop completely and secure the stop nuts before using the oscillating feature. If the depth stop is left adjusted for a shallow hole, or the nuts rattle down to the stop while in operation, the depth stop will bottom out and break the oscillator.

To adjust the drilling depth, do these steps:

1. **UNPLUG THE DRILL PRESS!**
2. Rotate the oscillator pulley until the depth stop reads "0" (see **Figure 37**).
3. Loosen the jam nut on the depth stop rod (see **Figure 38**).
4. Turn the stop nut to the desired depth as indicated by the depth stop scale (see **Figure 38**).
5. Tighten the jam nut against the stop nut while making sure the stop nut stays in position.
6. To make sure the depth has been set correctly, drill a hole into scrap stock before drilling into any workpiece, and readjust the depth stop if necessary.

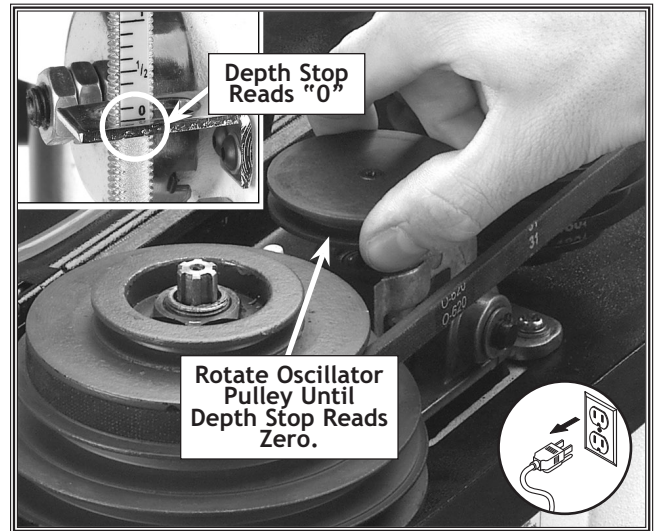

Figure 37. Retracting the oscillator for drilling.

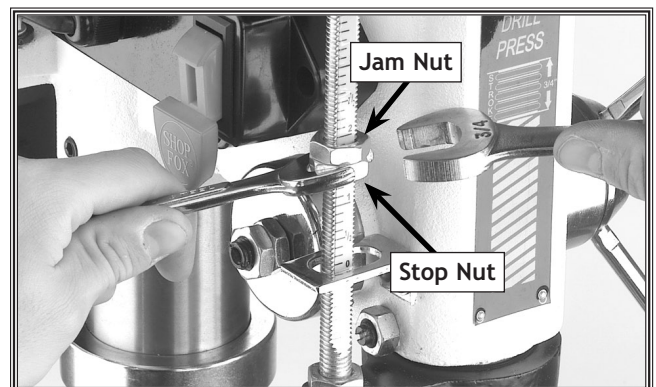

Figure 38. Actual stop depth being measured.

ADJUSTMENTS

Drill, Cutter, and Hole Saw Suggested RPM Chart

ALWAYS follow the drill, saw, or cutter manufacturer's recommended RPM specifications. **ALWAYS** wear safety glasses. **DO NOT** use your drill press to exceed the drilling, cutting, or sawing RPM or the feed rate of your bit or cutter. Otherwise serious personal injury can occur.

The RPMs listed below are merely suggestions to help you use your drill press in the event that you cannot find a basic starting RPM point. The final RPMs may differ based on the material drilled, the pressure you apply, and the cut-quality needed. Remember, even if the RPM and all other settings are correct, cooling the tool with a lubricant and drilling a pilot hole may also be required. Refer to **WARNINGS** and **TIPS**, trade journals, training manuals, and other educational resources for in-depth instructions and safety knowledge.

For current product line, refer to: <http://www.steelex.biz/drilling.cfm>.

Sanding Sleeves or Grinding Bits	Soft Wood	Hard Wood	Plastic	Brass	Aluminum	Mild Steel
1", 1-1/2", 2"	2000	1725	1000	3100	3100	3100
Twist Type Drill Bits: (Wood, Plastic, and Metal)						
1/16" to 3/16"	3000	3000	2500	3000	3000	3000
1/4" to 3/8"	3000	1500	2000	1200	2500	1000
7/16" to 5/8"	1500	750	1500	750	1500	600
11/16" to 1"	750	500	-	400	1000	350
Spade Drill Bits: (Wood)						
1/4" to 1/2"	2000	1500	-	-	-	-
5/8" to 1"	1750	1500	-	-	-	-
1-1/8" to 1-1/2"	1500	1000	-	-	-	-
Spade with Spur Drill Bits: (Wood and Plastic)						
3/8" to 1"	2000	1800	500	-	-	-
Brad Point Drill Bits: (Wood and Plastic)						
1/8"	1800	1200	1500	-	-	-
1/4"	1800	1000	1500	-	-	-
3/8"	1800	750	1500	-	-	-
1/2"	1800	750	1000	-	-	-
5/8"	1800	500	750	-	-	-
3/4"	1400	250	750	-	-	-
7/8"	1200	250	500	-	-	-
1"	1000	250	250	-	-	-
Forstner Drill Bits: (Wood and Plastic)						
1/4" to 11/16"	2400	1600	250	-	-	-
3/4" to 1-1/16"	1800	1200	250	-	-	-
1-1/8" to 1-7/16"	1200	800	250	-	-	-
1-1/2" to 2-1/8"	600	450	-	-	-	-
2-1/4" to 3-1/8"	480	250	-	-	-	-
Multi-Spur Drill Bits: (Wood)						
2-1/8" to 4"	250	250	-	-	-	-
Countersink Cutters: (Wood, Plastic, and Metal)						
2-Flute Cutter	1400	1400	-	-	-	-
5-Flute Cutter	1000	750	750	250	250	250
Plug Cutters: (Wood)						
3/8" to 1/2"	1200	1000	-	-	-	-
5/8" to 1"	800	600	-	-	-	-
Carbide Rosette Cutters: One-Piece Shear Type (Wood)						
2-1/2" to 3"	1800	500	-	-	-	-
Rosette Cutters: Replaceable Carbide-Knife Type (Wood)						
2-1/4" to 3-1/8"	350	250	-	-	-	-

WARNINGS and TIPS

- **WARNING:** The larger the drill bit or hole saw and the slower the RPM, the greater the chance the tool could aggressively grab the workpiece, damage the tool and workpiece and cause injury. High RPMs can melt plastic, burn wood, and dull the tool.
- **WARNING:** Use a 5-Flute cutter when cutting into plastics, brass, aluminum, and mild steel. A 2-Flute cutter can aggressively grab the workpiece and damage the tool.
- **TIP:** To increase the life of drill bits, cutters, hole saws, and improve cut quality, use a lubricant equivalent to these:
 - Plastics:** use a soapy-water lubricant
 - Brass:** use a water-based lubricant
 - Mild Steel:** use an oil-based lubricant
 - Aluminum:** use a paraffin-based lubricant
 - Cast Iron:** use a pipe-thread cutting lubricant
 - Wood:** use no lubricant.
- **TIP:** Raise the drill bit, cutter, or hole saw often to clear chips and cool the tool.
- **TIP:** When drilling plastics with spade bits, use a spade bit with spurs.
- **TIP:** Plug cutters and rosette cutters are for wood only; however, carbide-tipped bits and cutters cut at a higher RPM, and can cut materials other than wood depending on cutter type. Carbide makes better cuts and lasts longer than HSS steel.
- **TIP:** When using hole saws, apply firm and even pressure, so the saw teeth contact the surface all at the same time-not at an angle. You can also flip the workpiece and finish drilling from the other side.
- **TIP:** To prevent drill bit wandering, use a center punch to start the drill bit.

ADJUSTMENTS

Saws: Bi-Metal Hole Saws (Most Materials)															
Hole Saw Diameter	Soft Wood	Hard Wood	Plastic	Mild Steel	Cast Iron	Brass	Aluminum	Hole Saw Diameter	Soft Wood	Hard Wood	Plastic	Mild Steel	Cast Iron	Brass	Aluminum
9/16"	1150	870	1320	580	400	790	900	2-7/8"	240	180	275	120	80	160	180
5/8"	1100	825	1250	550	365	730	825	3"	230	170	260	115	75	150	170
11/16"	1000	750	1140	500	330	665	750	3-1/16"	220	165	250	110	75	150	170
3/4"	920	690	1050	460	300	600	690	3-1/8"	220	165	250	110	70	140	165
13/16"	850	635	970	425	280	560	635	3-3/16"	210	155	240	105	70	140	165
7/8"	780	585	890	390	260	520	585	3-1/4"	210	155	240	105	70	140	155
15/16"	740	555	845	370	245	495	555	3-5/16"	200	150	225	100	70	130	155
1"	700	525	800	350	235	470	525	3-3/8"	200	150	225	100	65	130	150
1-1/16"	650	480	740	325	215	435	480	3-7/16"	200	150	225	100	65	130	150
1-1/8"	600	450	685	300	200	400	450	3-1/2"	190	140	215	95	65	130	145
1-3/16"	570	430	650	285	190	380	425	3-9/16"	190	140	215	95	65	120	145
1-1/4"	550	410	625	275	180	360	410	3-5/8"	190	140	215	95	60	120	140
1-5/16"	520	390	595	260	175	345	390	3-11/16"	180	135	205	90	60	120	140
1-3/8"	500	375	570	250	165	330	375	3-3/4"	180	135	205	90	60	120	135
1-7/16"	480	360	545	240	160	315	360	3-13/16"	180	135	205	90	60	120	135
1-1/2"	460	345	525	230	150	300	345	3-7/8"	180	135	205	90	60	120	135
1-9/16"	440	330	500	220	145	290	330	4"	170	130	195	85	55	110	130
1-5/8"	420	315	475	210	140	280	315	4-1/16"	170	130	195	85	55	110	120
1-11/16"	410	310	465	205	130	260	295	4-1/8"	160	120	180	80	55	110	120
1-3/4"	390	290	445	195	130	260	295	4-3/16"	160	120	180	80	55	110	120
1-13/16"	380	285	435	190	125	250	285	4-1/4"	160	120	180	80	55	100	120
1-7/8"	360	270	400	180	120	240	270	4-5/16"	160	120	180	80	55	100	120
2"	340	255	385	170	115	230	255	4-3/8"	160	120	180	80	50	100	120
2-1/16"	330	245	375	165	110	220	245	4-7/16"	150	110	170	75	50	100	105
2-1/8"	320	240	365	160	105	210	240	4-1/2"	150	110	170	75	50	100	105
2-3/16"	310	230	355	155	105	205	240	4-9/16"	150	110	170	75	50	95	100
2-1/4"	300	225	340	150	100	200	225	4-5/8"	150	110	170	75	50	95	100
2-5/16"	290	215	330	145	100	195	225	4-11/16"	150	110	170	75	50	95	100
2-3/8"	280	210	320	140	95	190	220	4-3/4"	150	110	170	75	50	95	95
2-7/16"	280	210	320	140	95	185	210	4-13/16"	130	100	150	65	45	90	95
2-1/2"	270	200	310	135	90	180	205	4-7/8"	130	100	150	65	45	90	90
2-9/16"	270	200	310	135	85	175	200	5"	130	100	150	65	45	90	90
2-5/8"	260	195	295	130	85	170	195	5-1/4"	120	90	135	60	40	85	85
2-11/16"	260	195	295	130	85	165	190	5-1/2"	120	90	135	60	40	85	85
2-3/4"	250	185	285	125	80	160	185	5-3/4"	110	80	125	55	35	75	75
2-13/16"	250	185	285	125	80	160	185	6"	110	80	125	55	35	75	75

ADJUSTMENTS

OPERATIONS

Starting the Drill Press

Once assembly is complete and adjustments are done to your satisfaction, you are ready to start the drill press. Every time you start the drill press, you should follow these basic instructions.

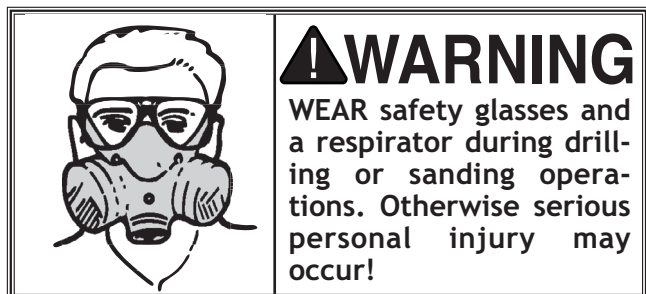

To start the drill press, do these steps:

1. Make sure the starting switch paddle is down for **OFF**.
2. Make sure all fasteners and lock handles are tight.
3. Make sure the drill chuck key is removed.
4. Plug in the power cord.
5. Lift the **ON/OFF** switch to start the drill press, and make sure that your finger is poised over the paddle, as shown in **Figure 39**, just in case there is a problem.
6. Listen and observe the drill press, it should run smoothly, with little or no vibration or rubbing noises.
 - If you hear strange or unusual noises, shut the drill press **OFF**, and wait for the spindle to stop moving.
7. Unplug the drill press and refer to the “**Troubleshooting**” table on **Page 28** to help isolate and correct the problem before using the drill press again.



Figure 39. Hand poised over a typical stop switch.

Drill/Drum Changes



WARNING
NEVER troubleshoot or adjust the machine while it is running. Wait until the machine is turned off, unplugged and all working parts have come to a stop before proceeding!

To change drill bits and sanding drums, do these steps:

1. **UNPLUG THE DRILL PRESS!**
2. Use the chuck key to open the chuck wide enough to accept the new bit or the sanding drum mandrel (see **Figure 40**).
3. Install the bit or mandrel so the chuck jaws will grab as much of the bit or mandrel shank as it can.
 - If you are installing a small drill bit, make sure it is held between three jaws instead of only two, and **NEVER** allow a chuck to grab the fluted body of drill bits.
 - If you are installing the sanding drum, install the paper and drum before installing the spindle into the drill chuck (contact your local **SHOP FOX**[®] dealer for drums and paper).
4. Tighten the chuck with the chuck key, using any of the three key end locations. (see **Figure 41**).
5. Choose the insert that has an opening which is approximately 1/4" bigger than the sanding drum chosen. For drilling, always use the table insert (see **Figure 42**) with the smallest opening. A table insert is not needed when a 2" drum is used.
6. Install the chosen table insert into the pocket in the top of the table.
7. Remove the chuck key and reconnect the power source.
8. Reverse these steps to remove the drill bit or sanding drum.



Figure 40. Installing bit.



Figure 41. Chuck key engaged.

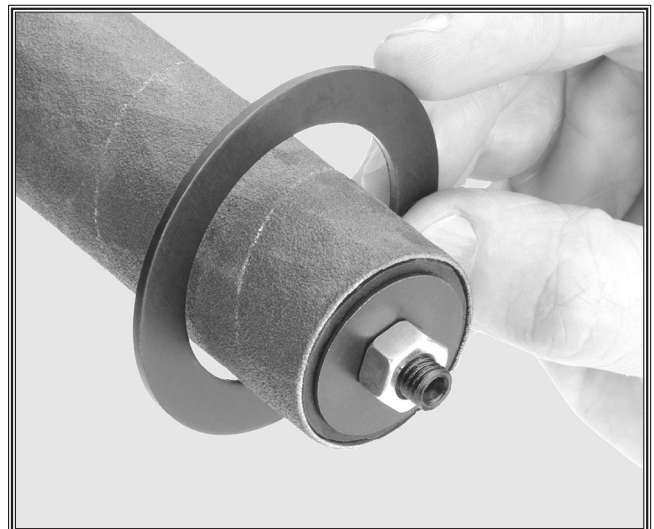
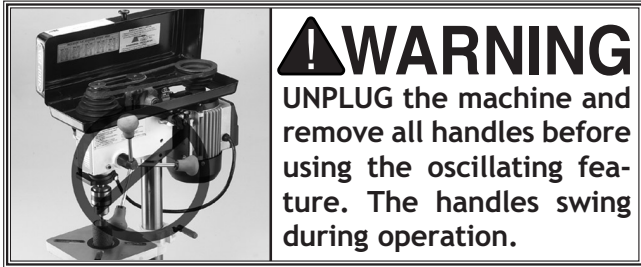

Figure 42. Sanding drum table insert.

OPERATIONS

Using the Oscillator

One of the great features of the Model W1668 13 1/4" Oscillating Drill Press is its sanding capability. The drill press can be converted from drilling operations to sanding operations in just a few steps.



To use the oscillating feature, do these steps:

1. **UNPLUG THE DRILL PRESS!**
2. Remove the spindle handles.
3. Lift the belt cover and remove the round belt located on the storage bracket under the speed chart, as shown in **Figure 43**.
4. Stretch the belt onto the top groove in the spindle and oscillating pulley, as shown in **Figure 44**.
5. Close the cover. The motor will not start until the cover is closed.
6. Loosen the jam nut for the depth stop and adjust both nuts until they are positioned at the top of the depth stop rod. Tighten the jam nut (see **Figure 45**).

NOTICE

ALWAYS back-off the depth stop completely and secure the depth stop nuts before using the oscillating feature. If the depth stop is left adjusted for a shallow hole, or the nuts rattle down to the stop while in operation, the depth stop will bottom out and break the oscillator.

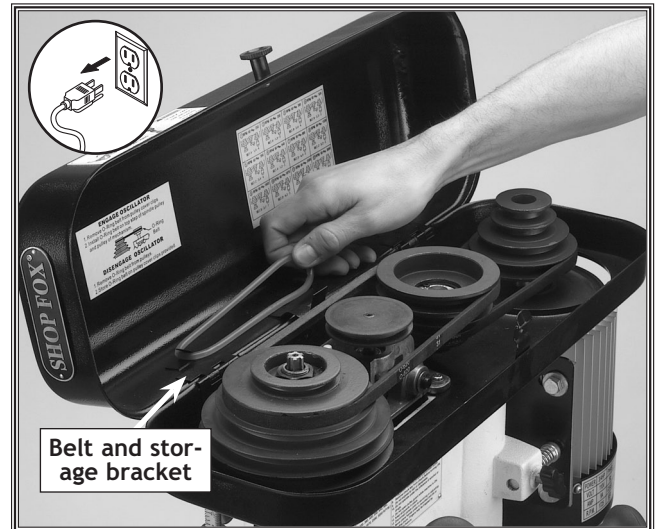

Figure 43. Oscillator belt on storage bracket.



Figure 44. Stretch the belt to fit on pulleys.



Figure 45. Back-off the depth stop nuts.

7. Remove the mandrel nut from the mandrel.
8. Install the sanding drum, sandpaper, and top and bottom mandrel washers on the mandrel, then secure with the mandrel nut, as shown in **Figure 46**.
9. Choose the insert that has an opening which is slightly bigger than the sanding drum chosen (see **Figure 46**).
 - For general drill bits, small reamers, and miscellaneous small cutting and sanding bits, use the 5/8" and the 1" table inserts.
 - For the 1" sanding drum, use the 1 3/8" table insert.
 - For the 1 1/2" sanding drum, use the 1 7/8" table insert.
 - For the 2" sanding drum, use no table insert.
10. Set the chosen table insert into the pocket in the top of the table, insert the sanding drum mandrel into the chuck, then tighten chuck (see **Figure 47**).
11. Loosen and pivot the table so the opening in the installed table insert is centered to the drill bit or sanding drum.

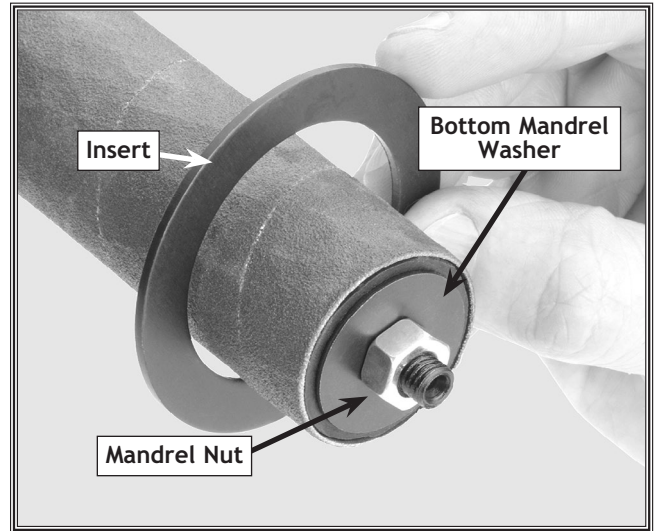

Figure 46. Sanding drum table insert.

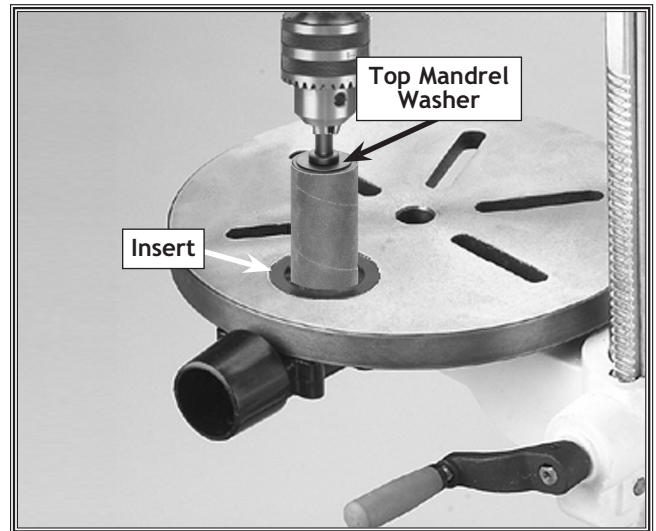

Figure 47. Sanding drum installed.



CAUTION

NEVER sand or drill without the table in position and the workpiece secured. Serious personal injury may occur.

OPERATIONS

12. Adjust the table height to use all of the grit on the paper as the paper wears.
 - If the thickness of the workpiece does not allow much table movement and the sanding drum paper is partially worn on one end, remove the drum from the sanding spindle, turn it end for end and replace it on the sanding spindle to use the newer part of the sandpaper.

13. Turn the drill press **ON**, and begin sanding.

MAINTENANCE

General

Periodic maintenance on your Model W1668 13¹/₄" Oscillating Drill Press will ensure its optimum performance. Make a habit of inspecting your drill press after each use.

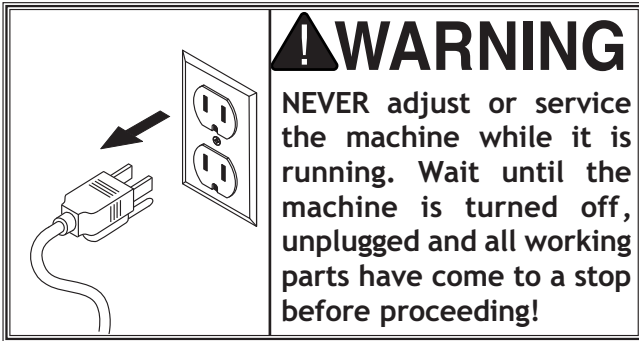

Check for the following conditions and repair or replace when necessary.

1. Loose mounting bolts.
2. Worn switch.
3. Worn or damaged cords and plugs.
4. Damaged drive belts.
5. Any other condition that could hamper the safe operation of this machine.

Lubrication

Since all bearings are shielded and permanently lubricated, simply leave them alone until they need to be replaced. **DO NOT** lubricate them.

For other items on this machine, such as the quill, table and column, an occasional application of light machine oil is all that is necessary. Before applying lubricant, clean off sawdust and metal chips.

Your goal is to achieve adequate lubrication. Too much lubrication will attract dirt and sawdust. Various parts of your machine could lose their freedom of movement as a result.

Table and Base

Keep the table and other unpainted surfaces rust-free with regular applications of products like Boeshield® T-9. For long term storage consider products like Kleen Bore's Rust Guardit™.

Sanding Sleeves

As sanding drums are used, the abrasive sleeve will quickly become "loaded" with sawdust. If not removed, this sawdust will harden on the abrasive surface, rendering the sleeve useless. Routinely clean the sanding sleeve with a rubber gum abrasive cleaner like the PRO-STIK® cleaners, as shown on **Page 30**.

Always discard worn sanding sleeves. As abrasive sleeves begin to wear, grit will begin to fall off and cause gouges in the workpiece. Glue used to hold the grit to the paper will rub off onto the workpiece interfering with the final finish.

NOTICE

Contrary to some beliefs, worn abrasives are not the equivalent the next finer grit abrasive. Discard worn sanding sleeves and avoid the temptation to use them beyond their usable life.

Troubleshooting

Use this table to isolate and correct any problems with your drill press. If you cannot correct a problem, contact Woodstock International, Inc. at 1-360-734-3482 or tech-support@shopfox.biz.

SYMPTOM	POSSIBLE REASON	HOW TO REMEDY
The drill press does not start.	<ol style="list-style-type: none"> 1. The pulley cover is not closed. 2. The power supply circuit breaker is tripped. 3. The power supply cord is damaged or has a poor connection. 4. The drill press power switch is at fault or is missing the yellow safety key. 5. The belt cover safety switch is at fault. 6. The motor is at fault. 	<ol style="list-style-type: none"> 1. Make sure there are no obstructions and close the pulley cover. 2. Get a qualified electrician to troubleshoot and correct the cause for the circuit breaker or fuse trip. 3. Make sure all connections are good, and replace the power supply cord if damaged. 4. Insert the safety key, and/or replace the power switch. 5. Replace the safety switch; do not repair it. 6. Replace the motor.
Drilling stops, but the motor still operates.	<ol style="list-style-type: none"> 1. The belt is loose or worn. 2. The pulley for the spindle shaft or the motor is slipping on the shaft. 	<ol style="list-style-type: none"> 1. Replace and/or adjust the belt. 2. To resecure the pulley, do these steps: <ol style="list-style-type: none"> a. UNPLUG THE DRILL PRESS. b. Remove the setscrew on the slipping pulley. c. Align the flat spot on the pulley shaft with the setscrew hole. d. Reinstall and tighten the setscrew.
The chuck wobbles or is loose on the spindle shaft.	<ol style="list-style-type: none"> 1. The chuck-retaining bolt is loose or missing. 2. Foreign material is stuck between the chuck-to-spindle mating surface. 	<ol style="list-style-type: none"> 1. Install and tighten a new chuck-retaining bolt. 2. Remove the chuck and clean and de-burr the tapered chuck and spindle mating surfaces, then reassemble.
The drill press does not oscillate.	<ol style="list-style-type: none"> 1. The oscillator belt is broken. 2. The oscillation mechanism is at fault. 	<ol style="list-style-type: none"> 1. Replace and/or adjust the belt. 2. Remove the oscillating mechanism and replace the broken parts.
The spindle does not retract completely in the uppermost position or it binds.	<ol style="list-style-type: none"> 1. The oscillator is not in the parked position. 2. The quill shaft is gummy with sawdust and oil. 3. The feed shaft return spring is weak. 4. The quill deflection screw is binding the quill. 	<ol style="list-style-type: none"> 1. Open the belt cover and rotate the oscillator pulley until the quill is fully seated up into the headstock, indicating the oscillator is parked. 2. Clean the gummy substance with penetrating oil and lubricate with a light coat of oil. 3. Increase the feed shaft return spring tension. 4. Loosen the jam nut, and slightly turn out the screw where the quill binds. Retighten the jam nut and recheck for binding and looseness at all spindle locations.
The quill has excessive deflection.	<ol style="list-style-type: none"> 1. The quill shaft is at fault. 2. The quill and/or bearings are worn. 	<ol style="list-style-type: none"> 1. Adjust the quill screw as described on Page 17. 2. Replace the quill and/or bearings.

Wiring Diagram

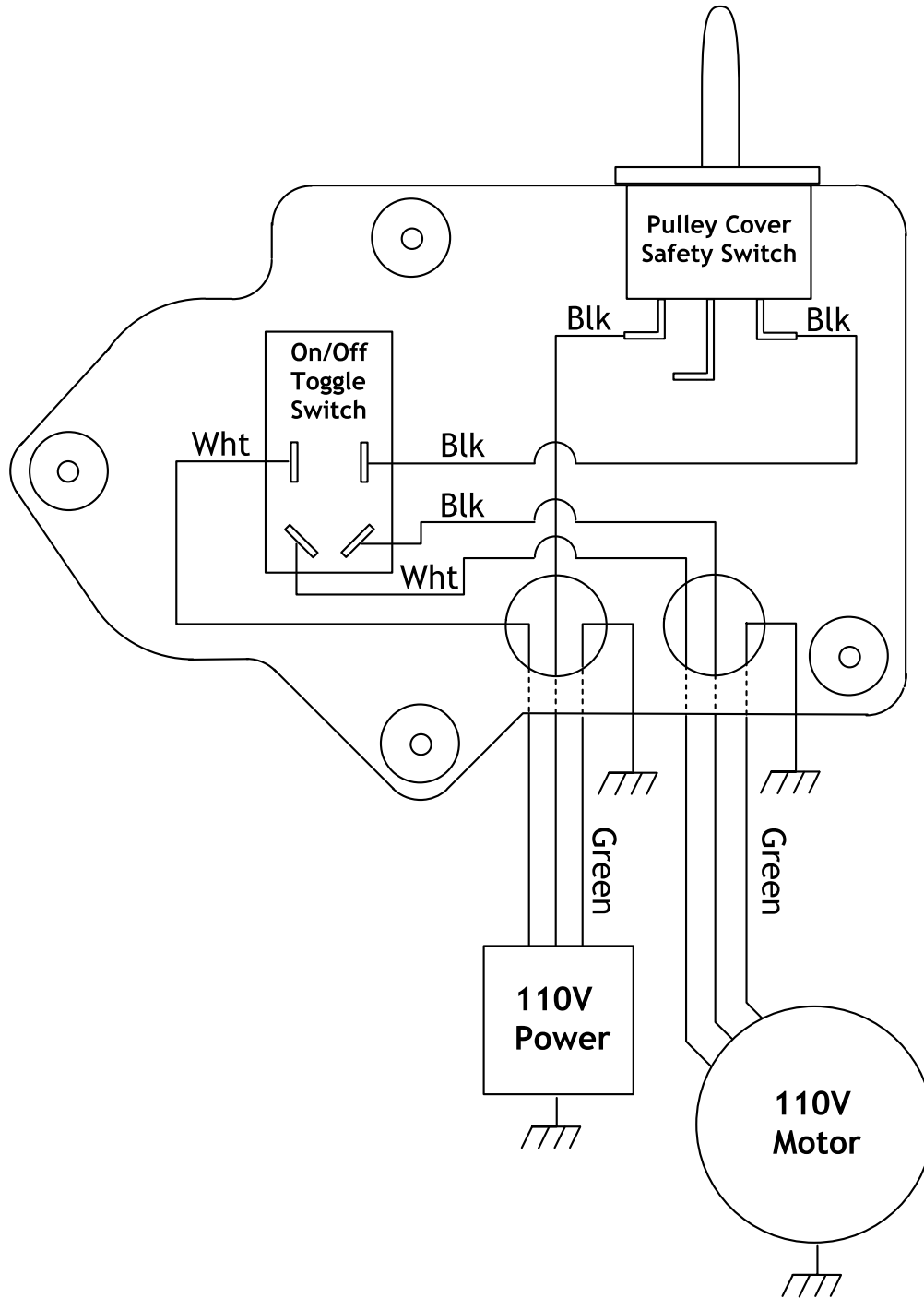

MAINTENANCE

Drill Press Accessories

The following drill press accessories may be available through your local Woodstock International Inc. Dealer. If you do not have a dealer in your area, these products are also available through online dealers. Please call or e-mail Woodstock International Inc. Customer Service to get a current listing of dealers at: 1-800-545-8420 or at sales@woodstockint.com.

Sanding Sleeves are sized to fit the D2677 Drum Sander Set. These hard Sanding Sleeves are available in 60, 80, 100, 120, and 150 grits. Keep plenty of these consumable Sanding Sleeves on hand.

Sanding Sleeves					
Size (Dia. x Ht.)	60 Grit	80 Grit	100 Grit	120 Grit	150 Grit
1" X 1/4"	D2683	D2684	D2685	D2686	D2687
1 1/2" X 1/4"	D2688	D2689	D2690	D2691	D2692
2" X 4 1/4"	D2693	D2694	D2695	D2696	D2697



The 4" **PRO-STIK® Stick with Handle** is the easiest solution for increasing the life of sanding sleeves by removing pitch and sawdust particles from the abrasive pores, which later harden in place if not removed. Simply press the cleaner lightly against the moving abrasive surface to remove clogged-up pitch and sawdust. PRO-STIK® cleaners are available in other sizes for any cleaning application that would need cleaners with handles, as blocks, or as flat pads. (Not recommended for wide-belt sanders.)

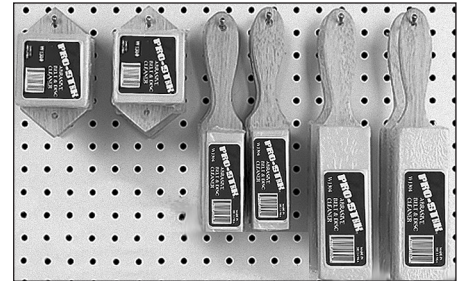

D2677 Drum Sander Set includes three rubber sanding drums 4 1/4" in length to accommodate 1", 1 1/2" and 2" diameter sanding sleeves. This kit also includes one 80 grit sleeve for each drum to get things started.

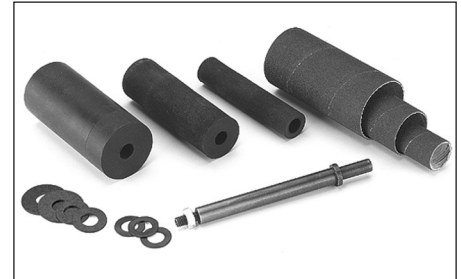

D2722 Mandrel is a 3/8" shank and is required to use our Drum Sander Set with any machine. Mandrel is included with the **SHOP FOX®** Oscillating Drill Presses featured above.

Drill Press Clamps adjust quickly and easily to lock your workpiece in any position. The clamping pad pivots to conform to any workpiece, ensuring uniform pressure.

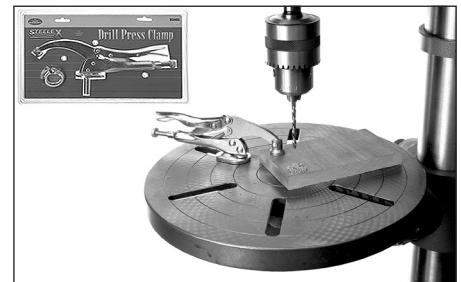

- W1301 6" Drill Press Clamp (1 1/2" Capacity)
- D2192 10" Drill Press Clamp (3" Capacity)
- D2493 12" Drill Press Clamp (5" Capacity)

SHOP FOX Drill Press Vises use precision ground steel guide rods, smooth-action Acme threads, ground steel jaws, with fixed jaw V-grooves for holding round stock, and dovetailed ways where applicable.

- D2727 SHOP FOX® (3" Basic Vise)
- D2728 SHOP FOX® (4" Basic Vise)
- D2729 SHOP FOX® (6" Basic Vise)
- D2933 SHOP FOX® (3 3/4" Angle Vise)
- D2730 SHOP FOX® (3" Cross Sliding Vise)
- D2731 SHOP FOX® (4" Cross Sliding Vise)

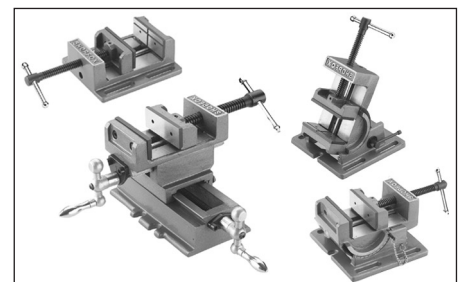

The **SHOP FOX® D2056 Tool Table** is great for bench-top tools like chop saws, drill presses, planers, scroll saws and bandsaws. Support cross braces on top provide incredible strength and capacity. Flared legs and adjustable rubber feet ensure stability and reduce machine vibration. Butcher block finish table top measures 13" x 23" and is 30½" tall with a 700 lb. capacity.



D2251 Steelex® Adjustable Circle Cutter cuts flat-sided holes in wood from 1" to 5". Made of M-2 alloy steel, this Circle Cutter features a 3/8" hex shank, 5/16" drill, center point and hex wrench.



D3161 Steelex® Heavy-Duty Carbide-Tipped Adjustable Circle Cutter is Carbide Tipped and cuts 1¾" to 5¾" diameter holes in the toughest material. For use with ½" drill press chucks. Includes hex wrench and 7/16" pilot drill.

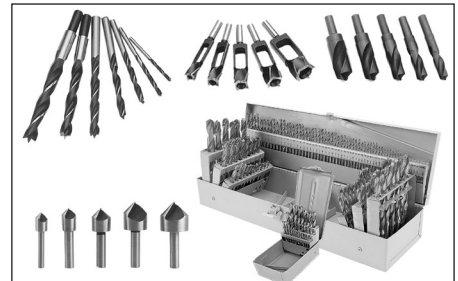

Woodstock offers a full line of **Brad Point Bits, Tenon/Plug Cutters, Countersink Bits, and Stubby Drill Bits** to satisfy every need. Whether for do-it-yourselfers or professional woodworkers, you can depend on Woodstock International Inc. to manufacture a useful selection of drilling and cutting tools. Refer to <http://www.woodstockint.com/drilling.cfm> for a complete product line available through your dealer.

Steelex® Carded Forstner Bits stack up as some of the best bits in the world. In fact, an independent testing lab proved that the Steelex® brand cut was equal to or better than Forstner Bits from Austria, known for being the best. For use with drill presses. Refer to <http://www.woodstockint.com/forstner.cfm> for a complete product line available through your dealer.



Steelex Plus® Bi-Metal Hole Saws stay sharper longer than carbon steel hole saws. Equipped with high-speed steel alloy cutting teeth bonded to a welded steel body, they cut wood, metal and plastics with ease.



- D2784 10-pc. Bi-Metal Hole Saw Set
- D2020 8-pc. Aggressive Hole Saw Set
- D2783 6-pc. Bi-Metal Hole Saw Set
- D2797 ½" X 20 UNF Hole Saw Arbor
- D2798 5/8" X 18 UNF Hole Saw Arbor
- D2799 12" Hole-Saw Arbor Extension
- D2928 Replacement Pilot Drill for D2797
- D2929 Replacement Pilot Drill for D2798

PARTS

W1668 Parts Breakdown

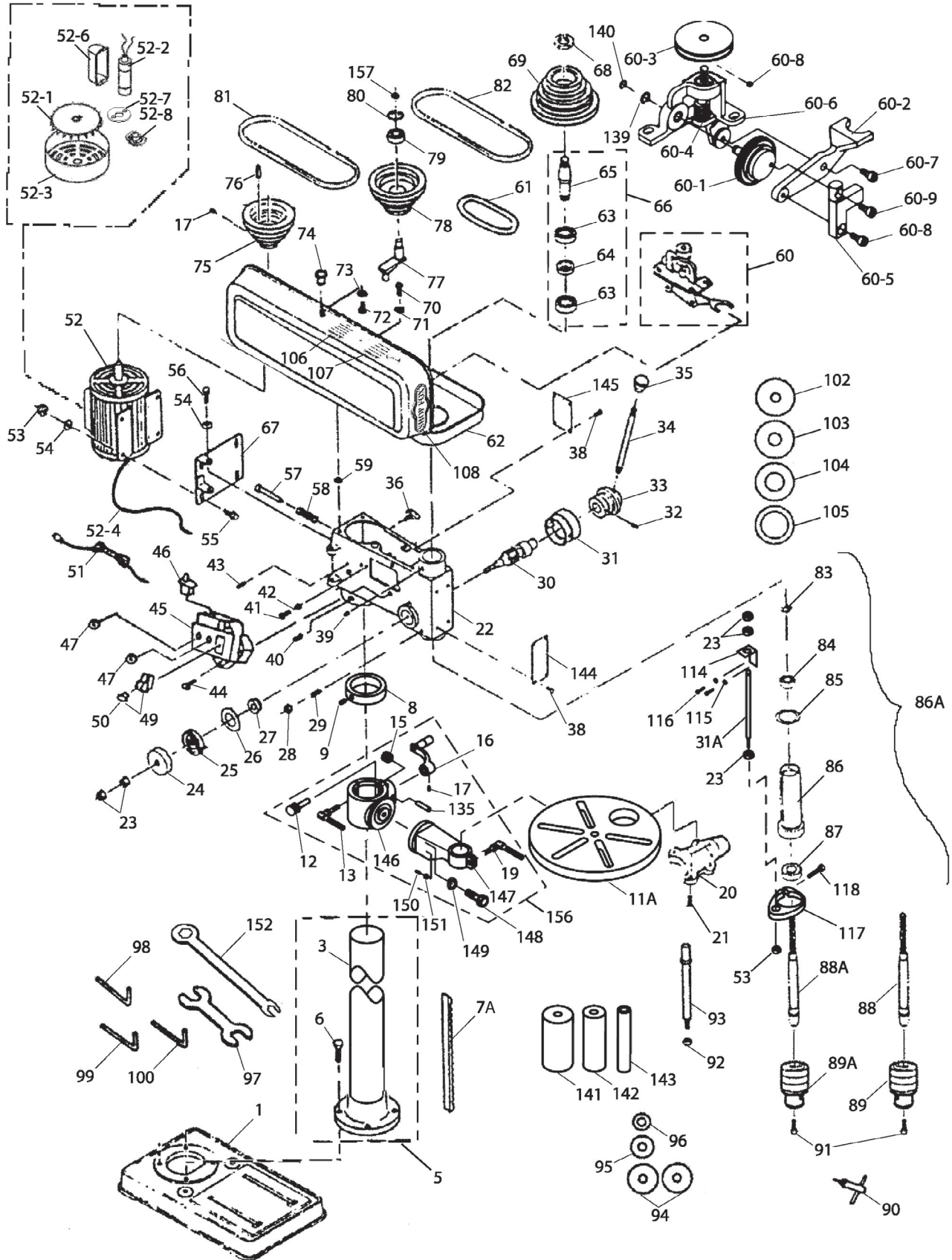

Parts List

REF	PART #	DESCRIPTION
1	X1668001	BASE
3	X1668003	COLUMN
5	X1668003-1	COLUMN & COLUMN FLANGE ASSEMBLY
6	XPB32M	HEX BOLT M10-1.5 X 25
7A	X1668007A	RACK V2.06.06
8	X1668008	COLUMN RING
9	XPSS01M	SET SCREW M6-1.0 X 10
11A	X1668011A	TABLE V2.05.03
12	X1668012	WORM PINION
13	X1668013	CLAMP BOLT M12-1.75 X 50
15	X1668015	WORM GEAR
16	X1668016	LIFT HANDLE
17	XPSS01M	SET SCREW M6-1.0 X 10
19	X1668019	CLAMP BOLT M10-1.5 X 30
20	X1668020	DUST PORT
21	XPS36M	PHLP HD SCR M4-.7 X 22
22	X1668022	HEAD CASTING
23	XPNO2M	HEX NUT M10-1.5
24	X1668024	SPRING COVER
25	X1668025	RETURN SPRING
26	X1668026	SPRING WASHER
27	X1668027	BUSHING
28	XPNO2M	HEX NUT M10-1.5
29	X1668029	SPECIAL SET SCREW
30	X1668030	FEED SHAFT
31	X1668031	DEPTH COLLAR V1.08.00
31A	X1668031A	DEPTH STOP ROD V2.04.02
32	XPRP07M	ROLL PIN 6 X 20MM
33	X1668033	FEED COLLAR
34	X1668034	HANDLE BAR
35	X1668035	KNOB
36	X1668036	LOCK KNOB
38	X1668038	RIVET
39	XPSS16M	SET SCREW M8-1.25 X 10
40	XPSS13M	SET SCREW M10-1.5 X 12
41	XPS32M	PHLP HD SCR M4-.7 X 10
42	X1668042	EXT TOOTH WASHER 4MM
43	XPRP07M	ROLL PIN 6 X 20MM
44	XPS32M	PHLP HD SCR M4-.7 X 10
45	X1668045	SWITCH BOX
46	X1668046	LIMIT SWITCH
47	X1668047	STRAIN RELIEF
49	XPSW09	SHOP FOX PADDLE SWITCH
50	XPSW09-1	PADDLE SWITCH KEY
51	X1668051	POWER CORD
52	X1668052	MOTOR 3/4 HP
52-1	X1668052-1	MOTOR FAN
52-2	XPC2005	S. CAPACITOR 125V/200M
52-3	X1668052-3	MOTOR FAN COVER
52-4	X1668052-4	WIRING HARNESS
52-6	X1668052-6	CAPACITOR COVER
52-7	X1668052B	CENTRIFUGAL SWITCH
52-8	X1668052C	CONTACT PLATE
53	XPNO3M	HEX NUT M8-1.25
54	XPW01M	FLAT WASHER 8MM
55	XPB07M	HEX BOLT M8-1.25 X 25
56	XPB09M	HEX BOLT M8-1.25 X 20

REF	PART #	DESCRIPTION
57	X1668057	PUSH ROD
58	X1668058	SPRING
59	X1668059	RUBBER WASHER
60	X1668060	OSCILLATING MECHANISM
60-1	X1668060-1	PLASTIC GEAR
60-2	X1668060-2	OSCILLATING MECHANISM ARM
60-3	X1668060-3	PULLEY
60-4	X1668060-4	WORM GEAR
60-5	X1668060-5	DRIVE ARM
60-6	X1668060-6	BODY
60-7	X1668060-7	SPECIAL BOLT FOR OSC. MECH ARM M6 X 20
60-8	X1668060-8	LOWER SHOULDER CAP SCREW
60-9	XPSB10M	CAP SCREW M5-.8 X 15
61	X1668061	OSCILLATOR BELT
62	X1668062	PULLEY COVER
63	XP6203	BALL BEARING 6203
64	X1668064	COLLAR
65	X1668065	INTERNAL SPLINE SLEEVE
66	X1668066	SPLINE SLEEVE ASSY (63-65)
67	X1668067	MOTOR MOUNT
68	X1668068	LOCK NUT
69	X1668069	SPINDLE PULLEY
70	XPS31M	PHLP HD SCR M6-1.0 X 20
71	XPLW03M	LOCK WASHER 6MM
72	XPS09M	PHLP HD SCR M5-0.8 X 10
73	XPW02M	FLAT WASHER 5MM
74	X1668074	KNOB
75	X1668075	MOTOR PULLEY
76	X1668076	KEY
77	X1668077	IDLER ARM
78	X1668078	IDLER PULLEY
79	XP6202	BALL BEARING 6202
80	XPR21M	INT RETAINING RING 35MM
81	XPVM20	V-BELT M-20 3L200 (QTY 1)
82	XPVM26	V-BELT M-26 3L260 (QTY 1)
83	XPR48M	EXT RETAINING RING 11MM
84	XP6201	BALL BEARING 6201
85	X1668085	RUBBER WASHER
86	X1668086	QUILL V1.08.00
86A	X1668086A	QUILL ASSY (83-88) V3.06.01
87	XP6202	BALL BEARING 6202ZZ
88	X1668088	SPINDLE V1.08.00
88A	X1668088A	SPINDLE FOR JT33 CHUCK V2.01.05
89	X1668089	DRILL CHUCK V1.08.00
89A	X1668089A	CHUCK 3-16 MM JT33 V2.06.02
90	X1668090	CHUCK KEY
91	XPSB15M	CAP SCREW M5-0.8 X 20
92	XPNO3M	HEX NUT M8-1.25
93	X1668093	MANDREL
94	X1668094	MANDREL WASHER - 1 3/4"
95	X1668095	MANDREL WASHER - 7/8"
96	X1668096	MANDREL WASHER - 5/8"
97	X1668097	WRENCH 14MM X 1/2"
98	XPW03M	3MM HEX WRENCH
99	XPW04M	4MM HEX WRENCH
100	XPW05M	5MM HEX WRENCH
102	X1668102	TABLE INSERT 5/8" I.D.

REF	PART #	DESCRIPTION
103	X1668103	TABLE INSERT 1" I.D.
104	X1668104	TABLE INSERT 1 3/8" I.D.
105	X1668105	TABLE INSERT 1 7/8" I.D.
106	X1668106	LONG HAIR SAFETY LABEL
107	X1668107	GLASSES SAFETY LABEL
108	X1668108	SHOP FOX LABEL
114	X1668031A-3	DEPTH STOP BRACKET
115	XPW02M	FLAT WASHER 5MM
116	XPSB33M	CAP SCREW M5-0.8 X 12
117	X1668031A-6	DEPTH STOP MOUNT
118	XPSB14M	CAP SCREW M8-1.25 X 20
135	X1668010A-3	AXLE
139	XPW01M	FLAT WASHER 8MM
140	XPR39M	EXT RETAINING RING 8MM

REF	PART #	DESCRIPTION
141	XD2677003	RUBBER DRUM 2" X 4-1/4"
142	XD2677002	RUBBER DRUM 1-1/2" X 4-1/4"
143	XD2677001	RUBBER DRUM 1" X 4-1/4"
144	X1668144	TRAVEL INDICATOR PLATE
145	X1668145	DATA LABEL
146	X1668010A	TABLE BRACKET N/S
147	X1668010A-1	COLUMN SUPPORT N/S
148	XPB51M	HEX BOLT M16-2.0 X 50
149	X1668111A	SPECIAL FLAT WASHER
150	X1668111B	SPECIAL PIN
151	XPN01M	HEX NUT M6-1.0
152	X1668152	SPECIAL WRENCH
156	X1668010A-2	COMPLETE TABLE BRACKET ASSY
157	XPR05M	EXT RETAINING RING 15MM

Warranty Registration

Name _____

Street _____

City _____ State _____ Zip _____

Phone # _____ Email _____ Invoice # _____

Model # _____ Serial # _____ Dealer Name _____ Purchase Date _____

The following information is given on a voluntary basis. It will be used for marketing purposes to help us develop better products and services. Of course, all information is strictly confidential.

1. How did you learn about us?

Advertisement Friend Local Store
 Mail Order Catalog Website Other:

2. How long have you been a woodworker/metalworker?

0-2 Years 2-8 Years 8-20 Years 20+ Years

3. How many of your machines or tools are Shop Fox?

0-2 3-5 6-9 10+

4. Do you think your machine represents a good value? Yes No

5. Would you recommend Shop Fox products to a friend? Yes No

6. What is your age group?

20-29 30-39 40-49
 50-59 60-69 70+

7. What is your annual household income?

\$20,000-\$29,000 \$30,000-\$39,000 \$40,000-\$49,000
 \$50,000-\$59,000 \$60,000-\$69,000 \$70,000+

8. Which of the following magazines do you subscribe to?

<input type="checkbox"/> Cabinet Maker	<input type="checkbox"/> Popular Science	<input type="checkbox"/> Wooden Boat
<input type="checkbox"/> Family Handyman	<input type="checkbox"/> Popular Woodworking	<input type="checkbox"/> Woodshop News
<input type="checkbox"/> Hand Loader	<input type="checkbox"/> Practical Homeowner	<input type="checkbox"/> Woodsmith
<input type="checkbox"/> Handy	<input type="checkbox"/> Precision Shooter	<input type="checkbox"/> Woodwork
<input type="checkbox"/> Home Shop Machinist	<input type="checkbox"/> Projects in Metal	<input type="checkbox"/> Woodworker West
<input type="checkbox"/> Journal of Light Cont.	<input type="checkbox"/> RC Modeler	<input type="checkbox"/> Woodworker's Journal
<input type="checkbox"/> Live Steam	<input type="checkbox"/> Rifle	<input type="checkbox"/> Other:
<input type="checkbox"/> Model Airplane News	<input type="checkbox"/> Shop Notes	
<input type="checkbox"/> Modeltec	<input type="checkbox"/> Shotgun News	
<input type="checkbox"/> Old House Journal	<input type="checkbox"/> Today's Homeowner	
<input type="checkbox"/> Popular Mechanics	<input type="checkbox"/> Wood	

9. Comments: _____

FOLD ALONG DOTTED LINE

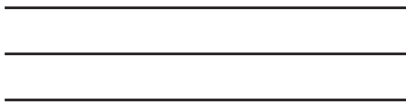

Place
Stamp
Here

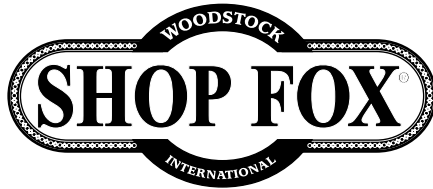

WOODSTOCK INTERNATIONAL INC.
P.O. BOX 2309
BELLINGHAM, WA 98227-2309



FOLD ALONG DOTTED LINE

TAPE ALONG EDGES--PLEASE DO NOT STAPLE

WARRANTY

Woodstock International, Inc. warrants all Shop Fox machinery to be free of defects from workmanship and materials for a period of two years from the date of original purchase by the original owner. This warranty does not apply to defects due directly or indirectly to misuse, abuse, negligence or accidents, lack of maintenance, or reimbursement of third party expenses incurred.

Woodstock International, Inc. will repair or replace, at its expense and at its option, the Shop Fox machine or machine part, which in normal use has proven to be defective, provided that the original owner returns the product prepaid to a Shop Fox factory service center with proof of their purchase of the product within two years, and provides Woodstock International, Inc. reasonable opportunity to verify the alleged defect through inspection. If it is determined there is no defect, or that the defect resulted from causes not within the scope of Woodstock International Inc.'s warranty, then the original owner must bear the cost of storing and returning the product.

This is Woodstock International, Inc.'s sole written warranty and any and all warranties that may be implied by law, including any merchantability or fitness, for any particular purpose, are hereby limited to the duration of this written warranty. We do not warrant that Shop Fox machinery complies with the provisions of any law or acts. In no event shall Woodstock International, Inc.'s liability under this warranty exceed the purchase price paid for the product, and any legal actions brought against Woodstock International, Inc. shall be tried in the State of Washington, County of Whatcom. We shall in no event be liable for death, injuries to persons or property or for incidental, contingent, special or consequential damages arising from the use of our products.

Every effort has been made to ensure that all Shop Fox machinery meets high quality and durability standards. We reserve the right to change specifications at any time because of our commitment to continuously improve the quality of our products.

